

Soberton & Newtown

PARISH MAGAZINE For all the community, delivered FREE to over 700 households

April - May 2026



Soberton Parish's western boundary
The River Meon at Mislingford Bridge
Photo by Jonty Sherwill
14th March 2026 at 11:40

www.sobertonchurch.org.uk
www.newtownchurch.org.uk

Cover design: Jonty Sherwill

St. Peter's, Soberton and Holy Trinity, Newtown

For details of Benefice and other local church services, please refer to page 4

Benefice of Soberton, Newtown and Hambledon

The Reverend Liz Quinn, Associate Priest in the Meon Valley Parishes.
Particular focus on the Benefice of Soberton, Newtown and Hambledon.
revliz7@icloud.com 07518 247637

Barn Church

Emma Andersen, leader of Barn Church.
Associate Priest in the Meon Valley Parishes emma.barnchurch@gmail.com

Our Lady Queen of the Apostles, Roman Catholic Church

St. Martin's Street, Bishop's Waltham, SO32 1DN
Father Mario Toma 02380 612430 Parish Office 02380 273882
18.00 Saturday (First Mass of Sunday)
09:30 Sunday (There are Sunday evening services in Winchester and in Fareham.)

Meon Valley Methodist. All services at 10:30.

Shirrell Heath / Waltham Chase / Bishops Waltham / Swanmore / Hambledon

Soberton and Newtown Church contacts

Any additions or changes, please contact the editor

Newtown (N) Church Warden	Fra Wells	01329 834130
PCC Secretary (N)	Malcolm Padgett	01329 834684
Parish Safeguarding Officer (N)	Caroline Barfoot	htn.safeguarding@gmail.com
Soberton (S) Church Warden	Jackie Hunt	07940 649691
Parish Secretary Contact (S)	Jackie Hunt	07940 649691
Parish Safeguarding Officer (S)	Jackie Hunt	Stpc.safeguarding@gmail.com
Captain Of Bells (S)	Caroline Rogers	01489 877430
Churchyard Keeper (S)	John Lester	01489 878557

MAGAZINE COMMITTEE & PRODUCTION TEAM

Chairman	Perry Abbott	02392 632338	cpgabbott@hotmail.com
Editor	Gill Gray	07711 058760	gill.highcroft@btinternet.com
Advertising	Kate Buttriss	07801 441998	kate.buttriss@gmail.com
Circulation	Pete Woodacre	01489 877768	petewoodacre@gmail.com
Treasurer	Jerry Lipscombe	07899 862235	lipscj3@gmail.com
Secretary	Paula Hobbs	07469 258022	paulajhobbs@live.co.uk

Typesetting of adverts and printing: Solent Design Studio solentdesignstudio.co.uk

Front cover design: Jonty Sherwill 01329 835161 www.sherwilldesign.com

Contents

4	❖ The Benefice of Soberton, Newtown & Hambledon – Services
	❖ Fresh air, exercise and open space! Help maintain Holy Trinity garden.
5	❖ Soberton and Newtown Good Neighbours Group
6	❖ Easter Workshop, Holy Trinity
7	❖ Children's Sunday Club
	❖ Another fun Messy Church on Friday 20th March!
8/9	❖ Newtown Church Fete 2026
10	❖ Soberton Village Hall - Chairman's Report Mar 2026
	❖ Support for families in our villages
	❖ Soberton and Newtown Ladies' Group
11	❖ Children's Week 2026
	❖ Soberton and Newtown Conservation Group
12	❖ St Peter's Church, Soberton – a resource that needs more financial support
13	❖ Soberton Fete 2026
14	❖ A new Queen's Guide
	❖ 2025 – a good year for ringing
15	❖ Afternoon Tea and Children's Bake Off at the Guide Hut!
16-31	❖ Classified Adverts – please support our local businesses
32	❖ Oscar - my four years at Droxford!
	❖ Rookesbury Hall – dates for your diary!
33	❖ What's on / contact numbers – local clubs and interest groups
34/35	❖ Local History ... Soberton's First Vicar
35	❖ Meon Valley Garden Club Spring Plant Sale
36	❖ In your garden ... Colour schemes and other dreams
37	❖ RBL - Droxford & District Branch
	❖ Pop in for coffee and cake at St Peter's
38	❖ Atlantic salmon's long journey back to the River Itchen (Hampshire & IoW Wildlife Trust)
39	❖ Meon Valley U3A
	❖ Interested in the Arts? The Meon Valley Arts Society
40/41	❖ Soberton Parish Council Chairman's Notes
41	❖ Earlybirds Needs Your Tesco Blue Token Vote!
42	❖ Winchester City Council – District Councillors
43	❖ Hampshire County Council – Farewell and thank you
	❖ Wickham Society Spring Programme
44	❖ Meon Valley Carers Group
	❖ Meon Valley Heartstart
	❖ Meon Valley Bowling Club
	❖ BW Photographic Society
45	❖ Mayor of Winchester's Community Awards
	❖ Meon Valley Lions Club
46	❖ Meon Valley Community Bus Timetable
	❖ A few useful numbers
47	❖ From the Archives
48	❖ Classified Advert – please support our local businesses

Please e-mail copy for the June / July magazine to
gill.highcroft@btinternet.com
NEXT COPY DATE - 11th May 2026 (17:00)

**The Benefice of
Soberton,
Newtown &
Hambleton**

Services

**April 2026
May 2026**

*Holy Communion is also
celebrated at Soberton at
09:30am every
4th Wednesday (before
coffee and cake)*

*and at Hambleton every
Wednesday at 09.30.*

*Subject to change,
sometimes at short notice*

April				
2 nd	1900	Holy Communion and Washing of Feet	Hambleton	
3 rd	1000	Easter Workshop (see page 6)	Newtown	
	1000	Walk of Witness	Hambleton	
	1400	Service of readings and reflections	Soberton	
	1400	Service of the Cross	Hambleton	
5 th	0600	Dawn Service	Hambleton	
	1000	Holy Communion	Newtown	
	1100	Holy Communion	Soberton	
	1100	Holy Communion	Hambleton	
12 th	1100	Holy Communion (Sunday Club)	Soberton	
	1100	Holy Communion	Hambleton	
19 th	1000	Holy Communion	Newtown	
	1100	Morning Worship	Soberton	
	1100	Service of the Word	Hambleton	
	1830	Evensong	Hambleton	
26 th	1100	Holy Communion	Hambleton	
	1800	Holy Communion	Soberton	
May				
3 rd	0800	Holy Communion	Hambleton	
	1000	Holy Communion	Newtown	
	1030	Short Family Service	Hambleton	
10 th	1100	Holy Communion (Sunday Club)	Soberton	
	1100	Holy Communion	Hambleton	
17 th	1000	Holy Communion	Newtown	
	1100	Morning Worship	Soberton	
	1100	Service of the Word	Hambleton	
	1830	Evensong	Hambleton	
24 th	1000	Holy Communion / Newtown Church Fete	Meonwood	
	1100	Holy Communion	Hambleton	
	1800	Holy Communion	Soberton	
31 st	1000	Holy Communion for Patronal Festival	Newtown	

**Fresh air, exercise and open space!
What more could you wish for?**

All yours and on your doorstep. And free, too!

What's the catch I can hear you say. Well, the catch is you would be helping your local church, Holy Trinity in Newtown, maintain the lovely gardens that surround the church including the Peace Garden and Garden of Healing. Help to keep them looking lovely all year round to be enjoyed by the visitors to the church and gardens.

No commitment necessary just call in as and when you can spare some time.

No experience necessary as you would be helped along the way.

If you are interested and would like more information, please contact Alan Marler on 07909 545562 or email alanmarler@outlook.com



Need Transport to Medical Appointments?

SOBERTON AND NEWTOWN Good Neighbours Group

We are here to drive local people, of all ages, to hospitals, GP surgeries, dentists, opticians and other health practitioners.

Our friendly volunteer drivers use their own cars, are all DBS checked and fully insured.

A donation towards fuel costs is requested.

For more information, call:

Kate Harvey on 07843 496 852 or Kate Chesters on 07710 716 664



www.soberton-pc.gov.uk



CAN YOU HELP US?

If you would like to *join* our driving team, we would love to hear from you. All our volunteer drivers decide which journeys they can offer, and are reimbursed for their mileage.

Soberton and Newtown Good Neighbours Group

The Soberton and Newtown Good Neighbours Group continues to be busy. On average, we make around 11 journeys each month, taking residents to a range of medical appointments. We are entirely run by volunteers and provide a vital service for people in Soberton and Newtown who are unable to drive.

In January, we organised an emergency life-saving skills training session for our volunteer drivers. The session was run by Meon Valley Heartstart and we also opened it up to other interested residents. 25 people attended what was a very interesting and informative session. We are grateful to Steve and Adrian from Meon Valley Heartstart for giving up their time to talk to us on a dark and rainy January afternoon.

In February, one of our group coordinators, Kate, visited Earlybirds Pre-School to make a donation. We sometimes have surplus funds from the mileage donations made by our clients and we like to donate to local community groups where we can. It was great to visit the pre-school and see the children happily enjoying their lunch. Kate also got to see the lovely learning spaces that have been created both indoors and outdoors. It is clearly a fun-filled and nurturing environment for our younger residents.

If you need help getting to a medical appointment, please do give us a call. We drive people of all ages. If you can give us some notice of your appointment that is always helpful, but we do try to assist with last-minute requests where we can.

We are always keen to welcome new drivers. It is a really rewarding group to be part of, and you can commit to as little or as much driving as you are able to. Please contact one of the two Kates if you would be interested in helping.

EASTER WORKSHOP

Good Friday 03 April
Holy Trinity, Newtown
10 - 12 noon



Donkey trail



Egg trees



Easter Garden Easter Frieze

Please do join us to celebrate
Easter at our children's activity
workshop at Holy Trinity

Donation of £2 welcome

More info from Granny
Hedgehogs aka Sue Wells
sjwells@meonwood.co.uk

07850 011820

Kids under 5 must be
accompanied by an adult

Children's Sunday Club

Second Sunday of each month 11am – 12 noon

Please join us for fun, learning and friendship.

All children welcome, any age!

Another fun Messy Church on Friday 20th March!

Messy Church Soberton and Newtown met on Friday 20th, after school from 15:30 – 17:15 at Holy Trinity, Newtown.



Soberton and
Newtown



The children arrived to a 'treasure hunt' based on 'what you would not normally see in a church'. A hairdryer, a packet of pasta and a koala bear certainly looked out of place! Aided and abetted by a drink and biscuits, energy levels were high!

The topic of this Messy Church was Palm Sunday. Through some fun worship and crafts, the children learned about this special day in the Christian calendar.

The children were quickly absorbed in the crafts ... making donkey headbands and palm cross bookmarks, decorating (and eating!) palm biscuits and starting the Easter frieze (more on that below!). Great fun all round – lots of noise and activity!

The session was rounded off with some quiet recapping and worship followed by a yummy sit down tea for the children. Tea, coffee and cake was well received by the mums and dads!.

Thank you all for coming! Watch this space for details of the next Messy Church.

A big thanks to the brilliant organisers and helpers!

Back to the Easter frieze! If you would like to be part of this and help finish the frieze, which will become part of the village Easter celebrations for a few years to come, please come to the Easter Workshop – details on the opposite page!



NEWTOWN CHURCH FETE 2026

looks forward to welcoming you on

Saturday 23rd May at Meonwood

Fete to be opened by Commander Charles Wylie OBE FCMI AfP

13.00 Classic and Interesting Car Display opens

13.30 Gates to the garden open

14.00 Opening Ceremony by Commander Charles

14:05 The fun and games begin!

Stalls * Sideshows
 Ice Creams * Home Made Teas
 Pet Farm * Grand Draw
 Barbecue and Beer Tent
 Classic/Interesting Cars and Tractors
 Pimms Tent
 Face Painting * Bouncy Castle
 Cuddly Duck Fishing
 Thomas the Tank Engine
 Arena Café * Prosecco Bar
 Treasure Hunt * Entertainment
 Auction of Promises
and so much more!



We look forward to seeing you!



Photos: John and Julie Earle



Newtown Church Fete team ... newtownfete@gmail.com

Stuart Doherty (Chair)	07734 200144	stuardoherty4@gmail.com
Gill Gray	07711 058760	gill.highcroft@btinternet.com
Matt Rees	07793 219705	matthewjrees@hotmail.com
Mike Guy	07984 802635	mikeguy@btinternet.com
Sue Wells	01329 834130	sjwells@meonwood.co.uk
Steve Scott	07783 738655	sascott200@gmail.com
Jason Bentley	07962 017046	jasonjbentley@live.co.uk

Stalls take cash only, but we have a cashpoint available should you run out!



NEWTOWN CHURCH FETE – Saturday May 23rd

How you can help make the day a big success!

Cakes!



Big cakes, little cakes,
sponge cakes, fruit cakes,
cupcakes, buns...what have
I missed! We love it all!
Please bake for the fete!



Sue Wells
01329 834130



Home Produce!

Jams, chutneys, pickles!
Sausage rolls, flans and
Quiches – all savouries,
yum yum!

Vegetables and more!
Check out your larders!

Barry & Miriam Rowswell
01329 834671

Tombola!



Bottles galore, please!

Spirits, wine, beer, soft
drinks ... all welcome!

Champagne?
Oh, yes please!



Sue Wells
01329 834130

Household & Gifts!



In a word, well in two!
Unwanted Gifts!
Time to clear out? Just call!



Sally Padgett
01329 834684
Zoe Phillips
07738 596493



Clearing out??

The Nearly New Clothes Stall

will take good, clean
clothes off your hangers!

Sue Wells
01329 834130

Auction of promises



The more 'lots', the better -
those that money 'just can't
buy' much appreciated!



Max Hennessy
07392 857576

Garden plants!

Always so popular – we all
love our gardens!

Tony Hardy
01329 834753



Books!



Fete goes browse!
Fiction, non-fiction books!

Please deliver to Meonwood

Children's Toys and games!

Outgrown, unloved?
Don't throw them away!



Louise Parker
01329 835692



Hook a Duck

...and the prize is a cuddly toy!

New and clean / good
condition used cuddly toys,
please!



Sarah Walton
01329 832320

White Elephant!

Not a real one!

We'd be delighted to
take your bric-a-brac
and other 'odds and
ends' off your hands!

Caroline Barfoot
07736 714565



All items and contributions can be delivered to Meonwood, PO17 6JZ, any time the week before or, if you need help with collection, please contact the stallholder or a member of the fete team (details opposite).

Thank you for your continued support!

SOBERTON VILLAGE HALL

Chairman's Report Mar 2026



There have been a number of upgrades to the Hall. The WiFi router was upgraded to improve access across the Hall rooms. A Projector screen has been added to the Blakes room to facilitate Business and Group use.

The Hall flat roofs have been upgraded with waterproof membranes with a commercial guarantee and meets our Insurance Company conditions. This has been very expensive and was funded from our Reserves.

We still have high electricity costs, and to run the Hall as environmentally friendly and economically as possible, we have now progressed three quotes for Solar panels helped by advisers recommended by Suzanne White, the local Green Party councillor. This has finally resulted in a Solar Grant application to South Downs National Park with expert help on the details from the Parish Council Chairman. We await news.

We have regular hirers providing opportunities to the village including - Bridge, Pilates for recovering patients, Soberton Players twice yearly productions, Table Tennis, Pilates exercise, Folk Association of South Hants and a newly introduced Faith group.

On top of this we provide excellent facilities for Village weddings, Wakes and Parties for all ages. This last year alone included around twenty parties.

Thanks to all those who use the Hall and we're always open to new hirers. If you have any thoughts on hiring the Hall or how facilities could be improved to the benefit of the village please talk to any of the trustees.

We continue to operate as a CIO (Charitable Incorporated Organisation) which provides a legal and financial protection to the trustees. A reminder that the Village Hall trustees are all unpaid and I thank them all for helping to run the Hall in such a professional manner – Sue, Bob, Rachael, Chris, Ben and new trustee Adrian.

Our purpose is to provide an asset for village life and we feel that has continued but we're always interested in anyone wishing to join our team as a Trustee. Please contact any of the trustees to explore membership.

Pete Woodacre - SVH Chairman

Further information is available on our website: www.sobertonvillagehall.co.uk

Contact at: sobertonvillagehall@googlemail.com

Support for families in our villages

Did you know that there is a small charitable trust available to any family, struggling financially, that lives in Soberton or Newtown?

If you would like help with trips, kit, uniform, or equipment for school, activity clubs or sports clubs etc., we would love to help you.

Please email us, in complete confidence, on Sobertoncharity@outlook.com. Just give us a few details of what you, or your child, needs and we'll get back to you as soon as we can.

Soberton & Newtown Ladies' Group

The planned speaker was unable to attend in February. We are very grateful to Chris Cole who stepped in at short notice and gave us an insight into shopping through the ages.

In March we heard about Hampshire Search and Rescue, a voluntary organisation doing sterling work searching for vulnerable missing people. A group of which many of us were unaware.

The venue for the meeting on 1st April is The Church Room, St Peter's Church, Soberton at 8pm. We are pleased to have Mandy Hagger, from Tudor Pest Control, talk to us again about being 'Passionate about Pests'!

On Saturday 2nd May we have our annual Progressive Supper.

Liz Whales (Secretary) 01489 877712
lizwhales@aol.com

Helen Stranks 01489 878270
helenstranks@btopenworld.com

Monday 27th – Thursday 30th July

Soberton and Newtown Parish
Children's Week

Holiday activity week



A week of wild, wonderful community-made fun



Soberton and Newtown Conservation Group

invites you to our

Annual General Meeting

at the Blakes Room, Soberton Village Hall

Wednesday 15th April at 6.30pm

for refreshments and a short review of our activities over the past year.

This is the perfect opportunity to meet the team which is doing so much to support the natural environment in our villages – and to talk to us about any ideas you may have to take this work forward.

For more info follow us on [Facebook.com/sobernewts](https://www.facebook.com/sobernewts)

St Peter's Church, Soberton – a vital spiritual and community resource that needs more financial support

St Peter's Church in Soberton has stood at the heart of this village since the 11th Century. It still stands there today, serving the entire community. It is here for everyone – for people of much faith, people of little faith, for people of other faiths, and especially for those who need love and support in times of sorrow, need or difficulty. **While we come from many different walks of life, we come together as one, and we welcome all..**



The core of our communal life is on Sundays, when we offer Holy Communion and Family Services on the 2nd, 3rd and 4th Sundays of the month, with a joint service – interchanging with Newtown – on the 5th Sunday.

Families and children are a treasured part of our community: once a month, we run a special Sunday School, and throughout the year we run group activities for children, especially at Christmas, Easter and over the Summer holidays. We run popular 'Messy Church' events every quarter.

The Church is not just about a building and Sunday worship. The Church Fete is held every year in June and is one of the highlights of village life. The Christmas Eve Nativity Service fills the Church to the brim. Our fine new Church Rooms adjoining St Peter's are used for many community events.

We seek to show God's love far beyond our own congregation. Each year, we marry couples, baptise children, and celebrate the lives of loved ones taken from us. At times like Harvest and Remembrance, people join us from far around. We reach into the community, providing pastoral listening and support whenever it is wanted, for all, and actively supporting local charities.

All this costs money! A big burden rests on a very few shoulders, and we seek more help.

We receive collection money and pledged money. Hitherto the **church fete** at the end of June has accounted for about one-third of annual church

income, but (with fewer volunteers happy to help and no one standing up to chair the fete committee) it will be much smaller this year – but no less precious. A suitable chairperson is still needed: it's not just about chairing meetings. The challenge is recruiting volunteers from across the village to run stalls and attractions, help rigging and unrigging on or near the day, assist with car parking and generally keeping the entire operation going.



Meanwhile we have substantial outgoings. The church receives no financial help from the Church of England or the Diocese of Portsmouth. In fact, the opposite is true: the Diocese relies on individual churches to pay a Parish Share for some 50% of its income. This is calculated on the presumed 'wealth' of each parish and used to pay for clergy, support staff, pensions and the mission of the wider church. Our share has decreased slightly, but we will still be expected to contribute £15,000 to the Diocese in 2026. In addition, another £20-25,000 must be raised to run the church itself – insurance, utilities, maintenance, etc; as a Grade One Listed Building, the cost of maintenance is unpredictable and expensive. Some £35-40,000K must therefore be raised locally every year and, with a much smaller fete, we're predicting a shortfall of over £18,000 in 2026. Consequently, we are unlikely to be able to pay some or all of our share, which will in turn impact on the Diocese.

So, what can you do to help?

If you're already a regular donor, thank you – and can you spare a little bit more? If you don't already contribute, please consider setting up a Direct Debit that can be increased by 25% with a Gift Aid declaration. Maybe also consider making a small bequest to the church in your will. Every little helps, and means we can keep St Peter's at the hub of the community, conveniently placed alongside our other hub, The White Lion pub. After all, it's a time-honoured tradition to 'thirst after righteousness'!

So, the message is clear. St Peter's needs your help. If you would like to help, please contact the Honorary Treasurer at robmunroscott@aol.com or 01489 877800. Thank you!

By John Phillips and Rob Scott, Soberton Parochial Church Council (PCC)

S O B E R T O N
F E T E

27TH JUNE

SATURDAY, 1.30 PM

(GATES OPEN AT 1.00 PM)

**FOOD & DRINK, ENTERTAINMENT,
GRAND DRAW AND MUCH MORE!**

**CHURCH GREEN,
SOBERTON, SO32 3PF**

**ADULTS £2 CHILDREN UNDER 12 FREE
STALLS ARE MAINLY CASH ONLY
CASH MACHINE ONSITE**

A new Queen's Guide



It is with immense pleasure that I announce that **Victoria Rogers** has been awarded the highest Guiding Award – The Queen's Guide Award.

The Queen's Guide award is all about personal challenges and taking part in guiding. It's made up of 5 sections:

- **Personal development challenge:** Develop a skill in or outside of Girlguiding to enhance your personal growth.
- **Guiding challenge:** Make a difference in guiding by doing 4 projects focused on girls, volunteers, growth and retention, and inclusion.
- **Community action challenge:** Increase your knowledge of an important issue through research and practical activities, and then share it.
- **Lead the way challenge:** Try a new outdoor environment; try something new and adventurous or an exploration.
- **Social experience challenge:** Experience something you've never done before and develop your interpersonal skills by going on a residential or attending an event.

Victoria has been working on her Queen's Guide while studying for her Master's in Archaeology and supporting Soberton & Newtown Brownie and Guide Units here in the village, as well as a Brownie & Rainbow Unit in York.

Caroline Rogers

Unit Leader for Soberton & Newtown Guides



Victoria receiving her award from Our County Commissioner, Victoria Ling-White at our recent Division celebrations for 100 years of Guiding's World Thinking

2025 – a good year for ringing!

2025 proved to be a great year for the St Peter's ringers. The commitment from the band enabled us to ring for most, if not all, of the Sunday services, and run all but one practice nights during the whole year. This has only been possible with some support from our ringing friends in Hambledon, Droxford and Upham, but is an achievement we shouldn't underestimate.

Our ringing has improved, striking is much better and ringers are now starting to hear their own bells. We may not have all cracked Bob Doubles yet but we are close and everyone has been moving round to different bells within the tower – this makes it so much more enjoyable for everyone and gives us all an opportunity to ring on light & heavy bells.

We had an excellent Outing in June, organised by Jill our secretary, and attended the Benefice Christmas Gathering in December.

Various members have been visiting other towers and attending District meetings, so Soberton has been well represented in the District.

During the year we had seven visiting towers, held a district 8-bell ringing competition, rang for two weddings and a christening, and held a ¼ peal, alongside our celebration ringing for Easter, Christmas and the 80 year anniversary of the end of the war.

We are grateful to the PCC and the Vicar for their support for the bells, and enabling us to continue to build our friendship bonds across the Benefice and District.

If you are interested in learning to ring, or would like to 'try it out', do get in contact. We have 8 bells at St Peter's but only regularly ring 6, so we always welcome new faces.

Caroline Rogers
Tower Captain for St Peter's, Soberton.
Email: SobertonRingers@gmail.com





Afternoon Tea and Children's Bake Off at the Guide Hut!

Come along and enjoy a delicious Afternoon Tea with succulent sandwiches, scrumptious cakes, & stupendous scones! Eat in or takeaway!

Plus, stalls, a raffle **AND** a Children's Bake Off! More details about the Children's Bake Off to follow on Soberton Echo – but we'll be judging cakes and baked goods on their look and taste in categories based on ages 5-10, 11-16!

Sunday, May 10th, 2026
3pm-5pm

Tickets on the door
or email guidehutsoberton@gmail.com

Adults - £7.50

Children - £5.00

The Guide Hut,
The Recreation Ground,
Heath Road,
Soberton Heath,
SO32 3QH

All profits will go towards the upkeep of the Hut.



STUDIO 6 DESIGN & PRINT

Business Cards & Letterheads • Leaflets & Flyers
Wedding Stationery • Funeral Orders of Service
Banners & Signage • Booklets & Brochures
Personal Stationery • Labels, Rubber Stamps & much more!

www.studio-6.co.uk

We have new premises!

PLEASE CONTACT US VIA PHONE OR E-MAIL

01329 832933 • print@studio-6.co.uk

EXPERT TAX ADVICE WITH A HUMAN FACE FOR THE MEON VALLEY

WATCHING OUT FOR THE NEXT GENERATION

Is IHT a factor in making my Will? Is a Family Trust a good idea?

PROPERTY OR WORK OVERSEAS

How does it affect my tax if I live, work or have property abroad?

FOR ENTREPRENEURS

Am I the only one wondering whether it's worth all the aggro?

PERSONAL TAX

What is the best way to order my tax affairs, in full compliance with the law?

SELLING MY BUSINESS

How much tax will I pay? What is my business worth?

Nicholas Ridge ^{Est}
TAX EXPERTISE

Oakleaf, Ludwells Lane, Waltham Chase, Southampton, SO32 2NP

t: 01489 899102 e: nicholas@nicholasridgecta.co.uk

www.nicholasridgecta.co.uk

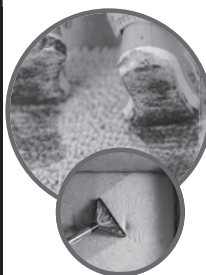

Elliott
CARPET CARE

Est. 2003

Enjoy professional cleaning that restores your carpets, making them look fresh again.

Local Family Run Business

☎ 07436 266078

🌐 www.elliottcarpetcare.co.uk

✉ elliottcarpetcare@gmail.com

Carpet Cleaning

Upholstery and Leather

Curtains and Suites



All aspects of Carpentry & Building work undertaken

- Extensions • Alterations • Refurbishments
- New Builds • Landscaping

Tel: 02392 632037 Mob: 07885 283036

jay.tucker16@yahoo.co.uk

Fully qualified and insured



The Perfect Space for Meetings or Committees

HOST YOUR NEXT MEETING OR
PRESENTATION IN A DISCREET AND
PRIVATE AREA.

RURAL LOCATION NEAR HAMBLEDON.

- Seating area for 6 to 8 people.
- Parking up to 4 cars.
- Ultra Fast Internet.
- Coffee, tea, cold drinks facility.
- WC.

ENQUIRIES:

Contact Ben **07973668539**
by text or WhatsApp

Discount offered for repeat or regular bookings.

FOR ALL YOUR DRY CLEANING AND LAUNDRY NEEDS

Duvets Laundered
Curtain Cleaning & Alterations
Tailor Repairs & Alterations
Wedding Dresses Cleaned & Boxed
Specialist Rug Cleaning Service



Laundry Service
Carpet Cleaning Machine Hire
Waxed Garments Cleaned & Re-Waxed
Pillows Cleaned & Recovered
Suede & Leather Cleaning

4 Merlin Mews, Bishop's Waltham. Tel: 01489 894421 • Agent: Meonstoke Post Office

www.bryantscleaners.co.uk

MARK & JUNE MASON

Husband and wife high quality painters and decorators. Period to modern properties, one room to a whole building. We work around your requirements.

www.masonspaint.co.uk

Phone 01329 235847

Mobile 07973 162397



SAFER CHIMNEYS

Member of National Association of Chimney Sweeps
NACS Certificates Issued.

“Highly Recommended” Local Chimney Sweep

Power Sweeping, Traditional Brushes,
Chimney Camera Surveys
Stoves, Open fires, Range Cookers
Less waiting time – 2 qualified sweeps

023 9247 6458 or 07733 343530 or 07847 466281

Proud members of
Checkatrade.com
Where reputation matters

www.saferchimneys.co.uk

WELLER PATRICK

SOBERTON AND MEON VALLEY PROPERTY EXPERTS

**Experienced local team with
detailed knowledge of the area.**

01489 893555

**www.wellerpatrick.com
info@wellerpatrick.co.uk**



If you're considering selling or renting your property, contact us for a free, no-obligation market appraisal.

ESTATE & LETTING AGENTS

The Square, Wickham, Hampshire PO17 5JT · Telephone: 01329 834579

Email: info@byrneandco.uk · www.byrneandco.uk



THE WHITE LION

BED & BREAKFAST

**BEER GARDEN,
FUNCTIONS, HOME
COOKING AND
LOCAL BEERS**

TELEPHONE: 01489 877346

INFO@THEWHITELIONSOBERTON.CO.UK
WWW.THEWHITELIONSOBERTON.COM

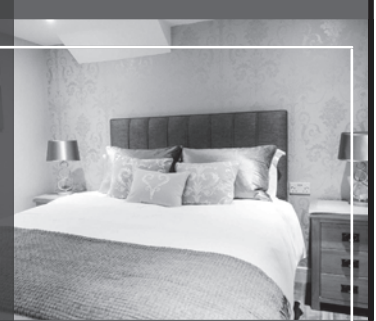

Pressing Needs



The Fabric Care Specialists

FREE

Collection & Delivery
Tuesday & Friday

25% off Duvet Cleaning
with Promo Code: S&N25

www.pressingneeds.co.uk
verity@pressingneeds.co.uk

- Laundry
- Dry Cleaning
- Ironing
- Shirt Service
- Bedding Laundry
- Duvet Laundry
- Curtain Cleaning

Duncan Rd, Park Gate, Southampton, SO31 1BD

01489 582095



MARK OLIVER Plumbing & Heating



All Domestic Plumbing Undertaken

Fully Insured & Qualified
Covering Your Area

Oil Boiler Heating Specialist

Oil Boiler Installation and Servicing

Approved Grant Boiler Installer

12 Month Guarantee on all Installations

BLUE LIGHT CARD & SENIOR CITIZEN DISCOUNT AVAILABLE

Contact: 07476 924619 / 01489 876556

24 hrs: 07743 386540



email: moliverplumbing34@gmail.com

www.moliverplumbing.co.uk



Mushroom Catering

Bringing Masterchef to the Meon Valley

Masterchef contestant Gill Holland provides bespoke menus that give your special occasion the wow factor! Traditional British fare, a Thai feast or a Mediterranean mezze, canapés at a drinks party to full wedding packages.

Whatever your event give Gill a call on the contact details below:

www.mushroom-club.co.uk
West Down Cottage, Chalk Hill,
Soberton, SO32 3PH
07879 696495, 01489 876741

Mowers

MEON VALLEY
SERVICE AND REPAIRS

Specialist in professional & domestic mower & garden machinery

- Service & repairs
- Collection & delivery
- Competitive rates
- Rotary blades, cylinders & hedge cutter sharpening
- Visit our workshop



07783 937212 or 01489 878085
info@meonvalleymowers.co.uk



MJM

Plumbing & Heating

36 years experience in the plumbing & heating industry

- Natural gas, L.P.G and oil boilers installed
- Oil tanks installed & maintained
- Power flushing
- Full bathroom installations including wall & floor tiling
- Unvented hot water systems installed, serviced and maintained
- Grant Oil Boiler Approved Installer

NO
CALL OUT
CHARGE

**NOW OFFERING 0% finance on all
Vaillant boilers and products!** Call for details

Tel: **01329 507712** Mob: **07773 385946**
info@mjmplumbing.co.uk www.mjmplumbing.co.uk



Based in Wickham

TJ

CHIMNEY SWEEPS

TEL: 02392 002872

MOB: 07950 145494

COMPETENT, CLEAN & RELIABLE

WWW.TJCHIMNEYSWEEPS.CO.UK

FULLY INSURED & REGISTERED WITH THE INSTITUTE OF
CHIMNEY SWEEPS.

SEE US ON CHECKATRADE.COM

To advertise please contact:

Kate Buttriss

kate.buttriss@gmail.com

07801 441998

All seasons general garden maintenance

Mob: 07763 494006 Tel: 01489 878 598

tudorgardener@gmail.com

@Tudorgardener

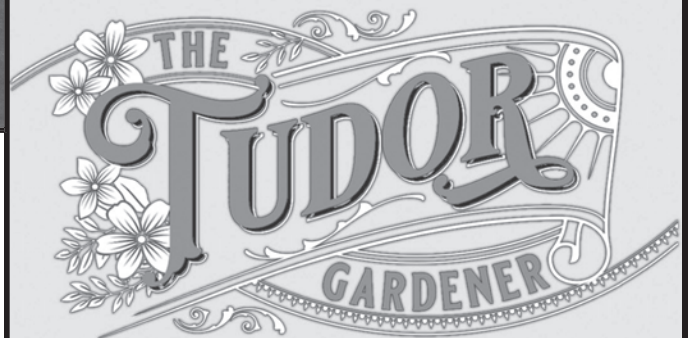

Specialising in:

- Hedge cutting & shrub shaping
- Garden design
- Fruit tree and rose pruning

RHS TRAINED

SYCAMORE TREE SURGEONS

All aspects of tree work

**Pruning Surgery Felling Hedgecutting
Tree Stump Removal and Site Clearance
Approved contractors for local authorities**

FULLY INSURED

023 9223 0146

Mob: 07889 704449 David Farrington

30 YEARS EXPERIENCE



J. Gordon

Forestry & Arboriculture Ltd

- Crown Reduction/Re-shaping • Thinning/Dead Wooding • Skilled Tree Removal • Hedges
- Plantation Maintenance • Tree Planting • Fencing • Woodland Management • Stump Grinding

Professional Qualifications • Insured in all aspects of forestry and tree surgery

For a personal and caring service contact Joe Gordon

24 HOUR EMERGENCY CALL-OUT • FREE QUOTATIONS

Hambledon 023 9263 2418 Mobile 07712 808 081 www.treedocjoe.co.uk



Taylor's Garage
Droxford
Hampshire SO32 3QL



Tel: 01489 877433

CAR and MOTORCYCLE MOTs

**Service and repair to cars
light commercials and horse trailers**

Air conditioning - service & repair

**Competitive prices on
tyres batteries and exhausts**

**Collection & delivery or loan car available
subject to availability**

BUY WITH CONFIDENCE
Trading Standards Approved Trader



PILATES

PILATES



Kate Broom Dip MCFHP MAFHP
Heels 2 Toes

Foot Health Practitioner

Caring and friendly foot care and maintenance



Located upstairs in
Birchall and Haydock Pharmacy,
The Square,
Wickham,
PO17 5JQ



07747 436359
Heels2toesuk@outlook.com

DBS checked and Insured

Member of the Southern Chiropody and Foot Health Practitioners Association and The British Association of Foot Health Professionals



SOLENT DESIGN

- Design
- Artwork
- Stationery
- Leaflets
- Flyers
- Brochures
- Booklets
- Newsletters
- Labels
- Postcards
- Folders
- Posters
- Banners
- Vinyl
- Exhibition Displays



Tel: 01489 892344 • Email: sales@solentdesignstudio.com
www.solentdesignstudio.com



ANDREW
SMYTH

Your local

HANDYMAN

DECORATING SERVICES

General Home Maintenance

Painting & Decorating

Carpentry & Fencing

Plumbing & Electrical

Domestic & Commercial

AND MUCH MORE...

07909 253681

andrew.j.smyth65@gmail.com



AndrewSmythHandyman

Wickham Fisheries

Your local Take Away
A wide variety of food

Gluten-free chips available everyday
Gluten free menu for other products
available every day (call and place your
order half an hour before collection)

Find all opening information and our menu
on Facebook – Wickham Fisheries

The Square

Wickham

PO17 5JQ

Tel 01329 832394



Local & Award Winning Luxury Self-Catering

- Ideal for family gatherings, celebrate here!
- Indoor heated pool and jacuzzi with hoist, sauna & steam room
- Hot tubs, en-suite bedrooms, wood burners
- Dog friendly, enclosed gardens, accessible
- Country views, EV charging points, free WiFi

WALLOPS WOOD COTTAGES
wallopswoodcottages.co.uk

GRENVILLE AT WALLOPS WOOD
grenvilleatwallopswood.co.uk

01489 878888

unwind@wallopswoodcottages.co.uk

Book with confidence and unwind with us

RICHARD STEEL & PARTNERS

THE FAMILY OWNED
FUNERAL DIRECTORS



Incorporating
Nigel Chamberlain
& Partners for
over 30 years

www.steelsfuneral.co.uk

BISHOP'S WALTHAM
The Gate House, Victoria Road,
Bishop's Waltham, SO32 1DJ
01489 892640

WINCHESTER
Alderman House, 12-14 City Road,
Winchester, SO23 8SD
01962 862333

Available 24 Hours

B.G. Property Maintenance

EST 1974

Internal and External Painting &
Decorating

Roof Repairs – Gutter Maintenance

Pointing – Brickwork & Plastering
Repairs

Glazing – Tiling – Paving – Carpentry

CLINT: 07836 620844

BOB: 07971 551513

Email: rgoble717@btinternet.com

FULLY INSURED
FREE QUOTES

BOWMAN

ALES LTD.

TRY OUR AWARD WINNING ALES



Our beers are
available in
bottles,
bags-in-boxes or
casks, all direct
from the brewery



01489 878 110

info@bowman-ales.com www.bowman-ales.com



Household and Business storage

02392 384 888

BARN-STORE.CO.UK

Offwell Farm, Southwick, Fareham, PO17 6DX



The Boat Bosun provides high quality,
shipwright, marine engineering, painting, and
coating service to traditional and modern boat
owners of wooden and GRP,
yachts and powerboats.

david@theboatbosun.com

07971 288064

theboatbosun.com

KS Groundworks

Local General Builders & Ground Maintenance, Hardscaping, Drives, Slabs, etc.

Over 30 years experience.

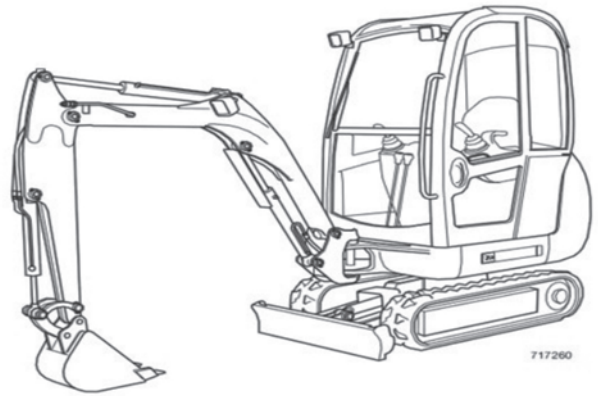

Tel: 07801 141517 Email: kym.slater@gmail.com

LOCAL FARRIER

(Soberton Based)

David Povey Dip WCF

For:

Hot & Cold Shoeing
Remedial Shoeing



Established 1985

01489 878218

Hurricane Farm



Our Services:

- Mobile educational farm
- Incubator hire
- Breeders of pedigree Tamworth and Gloucestershire old spots
- Breeder of rare breed poultry and garden hens
- Supplier of quality pork

01489 878218 - 07876244146

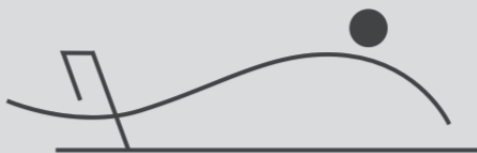

PILATES

H A M P S H I R E



YOUR FUTURE SELF IS WATCHING!

Improve the way you move every day

Enhance flexibility & mobility

Improve Spinal Alignment

Correct Posture

Strengthen the Deep Core

Beginners Welcome

**A PRIVATE (1:1) CLASSICAL PILATES
STUDIO
OFFERING TAILORED SESSIONS**

Fully equipped studio

Becky: 07891221630 **BGiulieri@gmail.com**



www.pilateshampshire.co.uk

CHAMBERLAINS

Family Solicitors

We can help you with a wide range of legal services including Residential Conveyancing, Commercial Property, Probate, Wills and Lasting Powers of Attorney

RED LION STREET (OFF HIGH STREET), BISHOPS WALTHAM
TEL: 01489 896141
info@chamberlainslaw.co.uk

StorAway

Your local choice for storage



Secure Storage for Classic Cars, Archived Documents and Personal Property. Long or short term storage options available.

For ALL your storage needs
Contact StorAway on 01489 877988
or www.storaway.co.uk

LBH LANDSCAPE & GROUND WORKS Ltd

Free Estimates - Quality Work - Competitive Prices

**Brick Laying • Block Paving • Patios
Concreting • Drainage • Extensions
Garages • Decking • Fencing • Turfing**

All other aspects of Hard and Soft Landscaping and Maintenance

KEVIN HALL 07808 496004
Tel: 01329 832169 Email: lbhkevinhall@gmail.com



G. RIXON LTD.

ELECTRICAL PLUMBING AND HEATING ENGINEERS



01329 834600

enquiries@g-rixon-ltd.co.uk

www.g-rixon-ltd.co.uk

We carry out small jobs such as attending to faulty light fittings and dripping taps, to larger jobs such as complete rewires and replacement bathrooms. We are disabled adaptation specialists and install level access showers and accessible kitchens.

G. RIXON LTD. Wynot Heath Road Soberton Hampshire SO32 3PQ



APARTMENTS FOR HIRE



Luxury One bedroom

We are offering this luxury apartments in Gosport. Fully furnished and equipped. High speed Internet.

ALL BILLS ARE INCLUDED

NO DEPOSIT, NO FIXED CONTRACT, NO MINIMUM OR MAXIMUM STAY.

IDEAL FOR:

Accommodation for business contracts.
Insurance placement.
Long term guests.
While house works are on going on.
Change of personal circumstances.
In between house moves.



For more information of pricing

CONTACT: Ben 07973668539

R & G GAMBLIN

Extension Alteration Renovation

Planning work

Bricklaying.
Civil Engineering.
UPVC Windows & Doors.
Plastic Fascia & Soffit.
Concrete.
Loft Conversion.
Roofing Pitch & Flat.
Painting.
Conservatories.

Digger Hire.
Drainage.
Fencing.
Plastering.
Driveways.
Plumbing.
Garages.
Carpentry.
Electrics.

For Free Estimates please phone
Rob 01489 - 891801



LOGS



Locally sourced, barn stored, seasoned hardwood logs

Delivered locally for free in bulk bags or loose loads.

Charges may apply for long distance deliveries

For enquiries contact Charlie

Email: hambledonlogs@gmail.com

Tel: 07788907334

TREE SERVICES

RESIDENTIAL & COMMERCIAL
HAMPSHIRE & SURROUNDING AREA

FOR MORE INFORMATION
www.wgstreeservices.co.uk

info@wgstreeservices.co.uk
or
CALL 07810 044 420



BULK BAGS

HARDWOOD | SOFTWOOD | KINDLING
FREE LOCAL DELIVERY

CALL 07810 044420
or

ORDER SECURELY ONLINE
www.wgskindling.co.uk

FOLLOW US

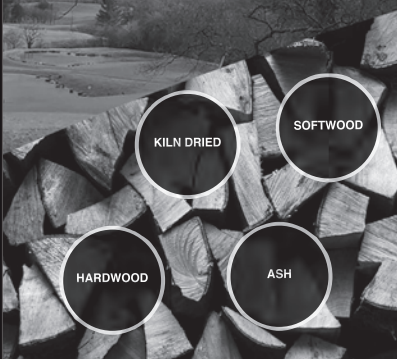

ICAEW
CHARTERED
ACCOUNTANTS

*Chartered Accountants
& Registered Auditors*

LOCAL INDEPENDENT ACCOUNTANTS AND
TAXATION ADVISORS

FREE INITIAL CONSULTATION

Full range of accountancy, auditing and taxation services

Business start up advice

Book-keeping and Payroll Services

Self-Assessment Returns

Detailed Fixed Cost Quotes

Visits to your Premises

Avalon House, Waltham Business Park,
Brickyard Road, Swanmore, Southampton,
SO32 2SA

Tel: 01489 896996 Fax: 01489 895255
Email: enquiries@butlerco-bw.co.uk
Website: www.butlerco-bw.co.uk

Strength,
flexibility
and
balance



BIRCH TREE
YOGA

Offering a range of
classes for all levels in a
woodland setting

birchtreeyoga.co.uk
07776238904



Tudor

PEST CONTROL

Mandy Haggart BSc.
07307 167 244

info@tudorpestcontrol.co.uk
www.tudorpestcontrol.co.uk

ECS
Easy Clean Services

Contact Us Now!
Tel: 01489 896 903

CESSPIT / SEPTIC TANK EMPTYING

TANK EMPTYING

- Cesspits
- Septic Tanks
- Interceptors
- Grease Traps
- Treatment plants
- Pump Stations



SERVICING

- All Treatment Plants
- Pump Sets
- Pumping Stations
- Water Pumps

PUMP and PARTS

- Air Blowers - All Makes
- Submersible pumps
- Spares and accessories
- Shop online or collect

DRAINAGE SERVICES

- Root Cutting
- CCTV Surveys
- Blocked Drains (Jetting/Rodding)

info@easycleanservices.co.uk
www.easycleanservices.co.uk

D.J. SCOTT
GARDEN MACHINERY

SALES & REPAIRS

Wheely Down Garages
Warnford, Nr. Southampton
Hampshire SO32 3LG

Telephone/Fax: 01730 829207
www.dj-scott.com

WINDOWS CLEANED TODAY

DM
EXTERIOR CLEANING
SERVICES

TRY OUR OTHER SERVICES

- Windows
- Gutters
- Fascia's & soffits
- Conservatories
- Roofs & Render
- Paving
- Bird proofing (chimneys & solar panels)

07815 698 140

bacs

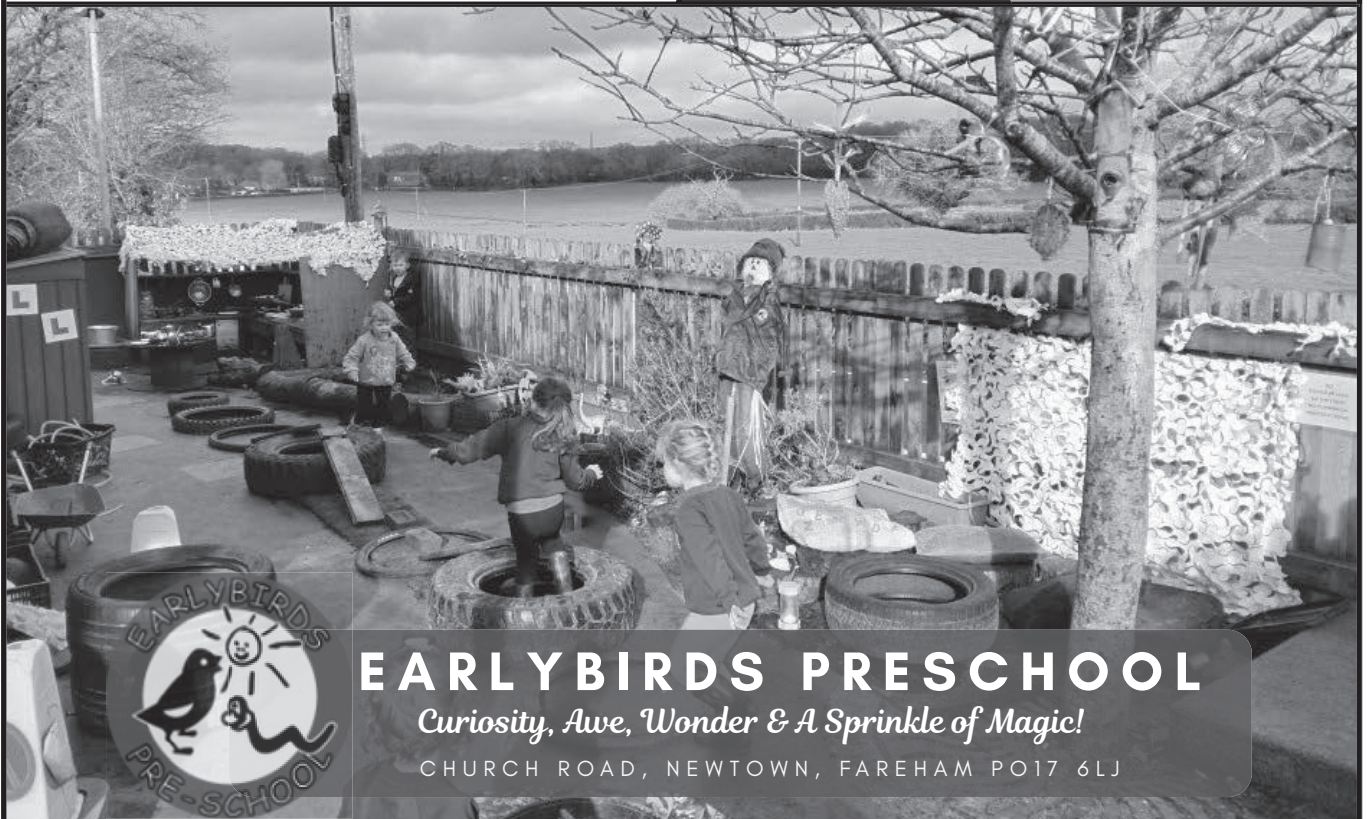

EARLY BIRDS PRESCHOOL

Curiosity, Ave, Wonder & A Sprinkle of Magic!

CHURCH ROAD, NEWTOWN, FAREHAM PO17 6LJ

- Open during term time for 2-4 year olds.
- Full wraparound care available.
- Great link with Newtown Soberton Infant School.
- Funding accepted.

www.earlybirdspreschool.co.uk

earlybirds16@hotmail.co.uk

07701259985

Ofsted
Good Provider

DROXFORD ANTIQUES

The Old Bakery, High Street, Droxford SO32 3PA

01489 878800 07973 551519 07815 562424 mark@droxfordantiques.co.uk

Established for over 40 years.

Still buying and selling antiques of all descriptions, valuations and probate service.

We repair, restore and polish in our own workshops.

CURTAIN MAKING, ALTERATIONS & UPHOLSTERY

Stockists of Kate Forman, Vanessa Arbuthnott, Ada & Ina

We offer a full service from measuring to making beautiful hand sewn curtains, blinds and pelmets especially for you.

Please telephone Mark or Mary for free, professional and confidential help and advice.



THE JOINERS SHOP

Period Joinery of Every Description

Conservation Approved
Double Glazed
Box Sash Windows

(Genuine) Handmade Kitchens

Tel: 02392 814780
enquiries@thejoinershop.co.uk
www.thejoinershop.co.uk



Associate Member of the Hampshire
Buildings Preservation Trust Ltd

Associated Trades



M & S LOCKE & SON LTD

PLASTERING & CERAMIC TILING CONTRACTORS

Specialising in:

- All aspects of plastering
- All aspects of tiling
(inc. porcelain & stone interior/exterior)
- Full bathroom refurbishments

Family run business with over 30 years experience,
we offer a reliable, friendly, and quality service.

**For a free quotation/advice please call Dean on
Mobile: 07712 894119/Home: 01489 877199**



HAMBLEDON GARDEN MACHINERY

All aspects of garden machinery
repairs and servicing, including
small plant & agricultural tractors
Delivery and collection available

Get in touch

☎ 07788 907334

WHITE ROSE PLUMBING

Russell Beaumont

Free quotation
No call out charge
No job too small
Family run local business
24 hour emergency service

Tel: **01489 893419** Mobile: **07843 586366**
Email: whiteroseplumb@googlemail.com

F A R E H A M Creek V E T S

32 East Street, Fareham PO16 0BY
www.farehamcreekvets.co.uk
Tel: 01329 280412

Local, independent small animal practice
Friendly, dedicated care for you and your pet
See the same vet at each visit
Close to Fareham town centre • Parking on site
24 Hours Emergency Service



CARTERS

GARDEN MACHINERY
SINCE 1921

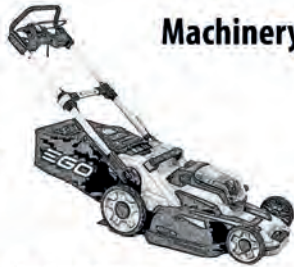

Machinery Sales | Service | Repairs | Hire

Robotic Mower Specialists
Free Site Surveys & Advice
Lawnmowers & Ride-Ons
Hedge & Brush Cutters
Chainsaws & Safety Clothing
Leaf Blowers & Vacuums



SEGWAY

STIHL

Mountfield

WEIBANG

Husqvarna

EGO

STIGA

ALKO

Call us on: **01489 575242**
Visit Our Store or Buy Online

www.cartersgardenmachinery.com



Duncan Road, Swanwick, Southampton, SO31 1BD. (Opposite Swanwick Railway Station. Follow the signs to the station from Park Gate.)



Oliver

CHIMNEY
S W E E P



OliversChimneySweep.co.uk

Brush 'n' Vac, Insured up to 5 million
All types of fires & appliances cleaned
Accredited certificate issued after every sweep

info@oliverschimneysweep.co.uk

0800 0133323

07889 488010



HAMBLEDON
CARS

PRIVATE HIRE SERVICE

Superior Air Conditioned Cars

**Airports, Stations
& Cruise Transfers**

Lisa & Mark:

07766 027 301

Email: hambledon-cars@hotmail.co.uk

VALLEY CARS

PRIVATE HIRE SERVICE

Superior Air Conditioned Minibus

Steve Eames:

07961 652 455

Email: valleycars2025@outlook.com

North ProBuild Ltd.

**General building, Extensions,
Refurbishments, Kitchens,
Bathrooms, Landscaping,
Driveways, Patios, Decking,
Equine Yards and Stables**

**Portfolio & References available,
helpful friendly reliable advice.**

Local Family run business in Soberton.

Please contact Darren

- ◆ darrennorth75@gmail.com
- ◆ 07946 106431
- ◆ 01329 833997



dwell design
ltd

A RIBA CHARTERED PRACTICE



Listed buildings



Bespoke residences



Conversions

"Anthony is a fantastic architect, who is passionate about what he does!"



PASSIONATE ABOUT SUSTAINABLE LIVING

01329 717515 | enquiries@dwell-design.co.uk

Leading the way in providing an **AFFORDABLE PROFESSIONAL** service

WESTMINSTER LAW

Wills ~ Estate Planning ~ Probate



If you are over 60 it will cost you only
£95* for us to prepare your Will.
We are also Lasting Power of Attorney
specialists - only **£120*** each LPA if
instructed during the Will appointment.
Our prices include VAT, home visits,
and Inheritance Tax advice.*

Call us now for a no obligation chat on
02392 706980

www.westminster-law.co.uk email: info@westminster-law.co.uk

Westminster Law Ltd, Reg. Office: Wellesley House, 204 London Road, Waterlooville PO7 7AN

*These very special rates are only available if you are over 60 years old. Minimum spend for a free home visit is £95.
Our normal price for a standard single Will is £160, or £270 for a couple.

Journeys of faith for discerning Christian travellers

£50 off*
any Fellowship
Tour for
all readers!

For over 40 years we've arranged pilgrimages for churches. In the last decade, we've developed our Fellowship Tours – designed for individual travellers who want to deepen their faith, explore places of Christian significance and share the journey with like-minded companions.

On a McCabe Fellowship Tour, you'll enjoy:

- ♥ Journeys to key biblical sites and Christian heritage locations
- ♥ Encounters with local food, art, history and people
- ♥ Daily worship and reflection led by an experienced McCabe leader
- ♥ Fellowship with other like-minded travellers

More than just travel, McCabe Fellowship Tours offer opportunities to grow, reflect and connect in some of the most inspiring places on earth.

*£50 off per person on any new booking for a McCabe Fellowship Tour made by 31st December 2025. Quote code 'PARISH50' when booking. Offer valid for new bookings only, cannot be combined with other discounts and is not transferable or redeemable for cash.

For more information:

 www.mccabe-travel.co.uk
 **01252 226133**







SDS ROOFING
SERVICES LTD

Celebrating



As a Limited company

Lead Work • Tiling • Shingles • Slates • High Performance Torch on Felt Systems
• Green Roofs • Single Ply Membranes • New Builds • Repairs

 www.sdsroofingservices.co.uk  **01489 788 577**  info@sdsroofingservices.co.uk



Computer Problems Solved

A qualified & experienced Computer Engineer who can efficiently solve your home and business computer needs.



For a friendly, no obligation quote call:

Chris Guénier: 01489 890738 or 07962 641796



<http://www.cps-ltd.org.uk>
info@computerproblemsolvedltd.co.uk

Mrs G's Pilates

- Enhanced core strength
- Improved flexibility
- Greater postural control



- Freedom of movement
- Self awareness
- Sense of well being

Tuesday Rooksbury Hall 0915-1015. **Wednesday** Meon Hall 0915-1015, Rooksbury Hall 1830-1930.

Thursday Denmead 0915-1015, Knowle 1100-1200, Rooksbury Hall 1830-1930

Friday Droxford 0915-1015 & 1030-1130

Contact Charlotte :07776221077 or charlotte@mrgspilates.co.uk



GATES
HOUSE
GARDENS

Beautifully built indoor and outdoor living spaces from a local, expert team.

Garden buildings, decking & patios • Driveways, walls & fencing
Design ideas & solutions • Building alterations & extensions
Drainage & groundworks



Jon has 30 years experience and a skilled and reliable team.
Give him a call or WhatsApp for an obligation free chat or quote.

gateshousegardens.com | 07885 663829 | @gateshousegardens

Oscar - my four years at Droxford!



I caught up with Oscar Light to ask him some reflective questions, following his initial interview in the Autumn of 2022.

How time flies by Oscar! What do you remember of the interview and starting school?

"I was very nervous and felt lucky to be interviewed"

What do you remember about Years 3 & 4?

"It went fast – Year 3 Camp and Butser Ancient Farm visit. I enjoyed the caving, rock climbing, shooting and archery at the Year 4 residential."

Who were your friends in the early years at Droxford?

"Archie, Isabelle, Evelyn and Rory (who I met at pre-school). I am still good friends with them now."

In the 2022 interview I asked Oscar about what he was looking forward to here. He replied "Harder Maths!"

What has the Maths been like at Droxford and what else do you enjoy?

"The Maths has been fun and also like Art and English. The maths has got harder throughout the years but it has help me progress. I like being creative in art.

What have you enjoyed participating in during your time in Years 5 and 6?

"I proud of being in the school core council and attending sports competitions and tournaments such as cricket, netball, basketball, cross-country and athletics. I also raced our battery powered car at Goodwood as part of the STEM club with Mr Dampier."

In 2022 you said you would like to be an Olympic Sprinter when you grow up. Is this still the case?

"I'd like to be a long-distance runner."

What else would you say about Droxford?"

"I've learnt a lot and experienced many things. We have had loads of authors in school – I really liked Kieran Larwood and I'm currently reading one of his books. Everyone has been very kind and helpful over the four years"

What next for Oscar?

"I am going to Swanmore College in Year 7. I am looking forward to even more sport"

What would you advise a new Year 3 child coming to the school to do?

"Enjoy yourself as the four years go really quick!"

Matthew Dampier
Headteacher



Rookesbury Hall – dates for your diary!

Saturday 7th November – murder mystery supper evening

Saturday 28th November – Makers Market

What's on

Month	Date/day	Event / group	Time	Details
April	1 st	S&N Ladies Group	20:00	Page 10
	3 rd	Easter Workshop	10:00	Page 6
	7 th	Stitch & Chatter	14:00	See below
	7 th and 21 st	U3A	14:00	Page 39
	7 th and 21 st	Soberton Ringers	19:30	Page 14
	8 th and 22 nd	Pop in for coffee and cake at St Peter's	10:00	Page 37
	12 th	Children's Sunday Club	11:00	Page 7
	14 th	The Meon Valley Arts Society	10:00	Page 39
	14 th	Wickham Society	19:30	Page 43
	15 th	S&N Conservation Group AGM	18:30	Page 11
	18 th	Meon Valley Bowling Club Open Day	-	Page 44
	24 th	Meet&Eat	12:30	See below
28 th	Meon Valley Carers Group	14:00	Page 44	
May	2 nd	S&N Ladies Group Progressive Supper	-	Page 10
	5 th	Stitch & Chatter	14:00	See below
	5 th	U3A	14:00	Page 39
	5 th and 19 th	Soberton Ringers	19:30	Page 14
	7 th	Soberton Parish Council Elections	-	Page 40
	9 th	Meon Valley Garden Club Spring Plant Sale	10:00	Page 35
	10 th	Children's Sunday Club	11:00	Page 7
	10 th	Guide Hut Afternoon Tea and Children's Bake-off	15:00	Page 15
	11 th	RBL	18:30	Page 37
	11 th	COPY DATE FOR JUNE / JULY	17:00	-
	12 th	The Meon Valley Arts Society	10:00	Page 39
	12 th	Wickham Society	19:30	Page 43
	13 th and 27 th	Pop in for coffee and cake at St Peter's	10:00	Page 37
	23 rd	Newtown Church Fete 2026	14:00	Pages 8/9
	26 th	Meon Valley Carers Group	14:00	Page 44
29 th	Meet&Eat	12:30	See below	
Hold the date	4 th June	BW Photographic Society	19:30	Page 44
	27 th June	Soberton Fete	13:30	Page 13
	27 th - 30 th July	Children's Week 2026	-	Page 11

CONTACT NUMBERS – LOCAL CLUBS AND INTEREST GROUPS

BROWNIES	SobertonNewtownBrownies@gmail.com	
GUIDES	SobertonNewtownGuides@gmail.com	
STITCH & CHATTER	Sandra Henderson	01489 877978
	Liz Whales	01489 877712
LOCAL HISTORY	Lyndon Palmer	07881 991763
SOBERTON PLAYERS	Susan Hyland	01489 878724
TABLE TENNIS	Pete Woodacre	01489 877768
	Adrian Hunt	01489 878141
LADIES GROUP	Liz Whales	01489 877712
CONSERVATION GROUP	Phil Bergin	02392 632551
MEET&EAT	Sue Musselwhite	sue@poppyhill.net

Local History ... Soberton's First Vicar

This seems an appropriate time to look back to Soberton, or rather St Peter's, first vicar who was appointed in 1897. You may be questioning this date which seems totally at odds with the age of the church but there are so many anomalies connected with Soberton.

First is why Soberton was not seen as a separate parish. Somewhere in the mist of time Soberton was deemed to be part of the parish known as Meonstoke cum Soberton. For practical purposes this meant that Meonstoke was the centre of administration with the mother church while Soberton had the status of a "a chapel of ease". However, this was not strictly the case because St. Peter's seems to have acted as a parish church and had its own burial ground 'from time immemorial' but the incumbent was, one expects, living near the mother church. Certainly in the later days of Soberton Chapelry it was cared for by a curate with the Rector overseeing important occasions.

The curate appointed in 1874 was the Rev. William Hammond Morley, a young enthusiastic cleric who found the church at Soberton in a very poor state of repair. William Hammond Morley was born c1843 the son of the Rector of Newport Pagnell in Buckinghamshire was unmarried and around thirty years old. He gained his B.A. at Worcester College Oxford in 1867 and his M.A. in 1871. Soberton is thought to be his second curacy. There is the hint of a promised position as Vicar in the near future. The Rector, Charles J. Hume was in his mid-seventies but there was little likelihood of him giving up St. Peter's voluntarily, the tithes from Soberton were too valuable. This despite the fact that the southern part of Soberton, since 1850, had become the new ecclesiastical parish of Newtown.

It is not known where William lived as an unmarried curate, other than the Banns were called in his parish of Droxford, but after his marriage to Mary Sophia Jones in London in 1878 it is thought they took up residence in Eden Lodge. The 1881 census of Droxford gives that address and Mary Rebecca, known as Molly, was then two old and a second daughter, Violet, was born there a year later. They finally moved to Soberton taking up residence in Soberton House just across Church Green from St. Peter's about 1886 when John Twynan and the house was available to rent. The Twynam family had provided accommodation for previous curates.

Quite when William started on the renovations to St. Peter's is not known but from his notes he writes "the church is falling into decay, rain comes in through the roof, the tower has been pronounced unsafe and the interior of the building is in an equally dilapidated condition." He also adds of the church tower "the walls cracked, timbers rotten and piers much shaken", and "the bells must be rehung". Some of this wording coming from the architect's report. His first task was surely to get the roof fixed and the church watertight. An appeal was launched "to send a little help to a very poor Agricultural Parish" where there are no resident gentry the only hope lies with "the help of generous friends of the Church and those who take an interest in the footprints of the past."

He was not the first caring curate to be faced with similar problems at St. Peter's. Stephen Butler had some fifty years earlier overseen renovations and restoration, some of which is criticized by Rev. Morley especially the replacement of the Norman font by a more modern one. Maybe the Rev. Butler raised some money by selling it because he, Stephen Butler, signed a document stating that the parish would not be asked to contribute to the repairs and that "we" hold ourselves responsible for the payment thereof. This implied the rector was part of the "we"

While the Morleys were still living in Droxford a second appeal was launched. The circular states that £1,800 was needed "to restore and resear" the church and that £1,500 had been secured. Several donations are noted but the outstanding amount came from an ingenious appeal for postage stamps if the circular is to be believed. It is not clear whether these were unused ones or how it would have been possible to raise a huge amount of money from the penny post. Having delved into the local history he used the story of the butler and the milkmaid building the church tower to appeal to all servants to help rebuild it with the promise that their names would be

displayed. When the tower was safe the bells were rehung and two more were added, the Rev Morley writes, 'by parishioners'.

The whole family must have spent every available minute either at the church or raising the required money. From his writings we know that Rev, Morley searched for the tomb of Bishop Walter Curle, the discoveries in the Curle Chapel were made by his wife in 1881 when she had a toddler and probably expecting another. These discoveries included the uncovering of the wall murals, the Aubrey in the corner and the three stone heads although, in one place, he attributes a stone head to his daughter. One can't help but wonder if the practical work was done by his wife while the research into the history of the objects was done by the curate!!

As well as the church restoration the couple turned their attention to a secular building – the neglected old school on the bank in the High Street. The Rev. Morley was keen to see this used as a meeting place for village people. This was at a time when the Temperance Movement was very strong and several local clergymen were establishing Reading Rooms where the men could meet as an alternative to the public house, the latter seen as the cause of many evils. Fifty pounds was the estimated cost of 'putting into order' the flint building with its thatched roof with another ten pounds needed for furnishings and three lamps. It opened in the spring of 1882.

Up until the Local Government Act of 1894 establishing Parish Councils the parish affairs were in the main carried out by the Vestry who appointed members to look after roads, the poor and the collection of the parish rate. Inevitably the vicar or rector was involved with these secular welfare issues as well as the spiritual. On a December evening in 1897 a crowded school room voted for the first parish council. There were twenty-one candidates for the eleven positions and the Rev. Morley was subsequently elected chairman.

It was the same year that William Hammond Morley was finally rewarded with the living of St. Peters and land was bought to build a vicarage on land close to the church in 1899. It is hoped his final twenty years as Vicar of Soberton were slightly more relaxing. Unfortunately, Mrs. Morley died in 1913 but his daughters were still with him before they moved to Chiddingfold on his retirement.



Spring Plant Sale **Saturday May 9th 10.00 -11.30**

Droxford Village Hall
Droxford High St. SO32 3PA

Sale of: Plants, Produce, & Home Baking.



In your garden ... Colour schemes and other dreams

When Barack Obama was having a particularly trying day, he would apparently often fantasise about abandoning the White House for Hawaii, where he would open a T-shirt shack that only sold white T-shirts in size medium. I have little in common with the former US President, but I too entertain a T-shirt based fantasy: making a small run of ethically produced shirts that read: 'Colour schemes are for Monty'.



We are so beholden to the views of others and what is 'in' and what is 'out' that we rarely think about what it is we like. If you like *Salvia* 'hot lips' and decide to do a whole border dedicated to them, that is your prerogative – even if the 'in' crowd say that 'hot lips' had its 15 minutes of fame over 10 years ago.

The trouble most of us have with the construction and composition of a border is that we have been raised British and by doing so we have been taught not to waste. If you don't eat ALL of your vegetables then you will not be allowed to have this luke-warm, skin lined semolina for pudding. Our borders suffer the same in that a shrub rose that is as old as the house sits slap bang in the middle of a border that you would quite like to be a prairie border containing grasses, *Soldago*, *Phlox* and other sun loving plants.

Until you can part with the plant – and moving the rose in winter is a good idea but one so old may or may not recover – you will always be at the mercy of what exists.

Another British trait that we bring to our gardens is our understated nature. Never looking to be the centre of attention, not wanting to make a fuss or cause a scene we apply the same to additions we make.

The addition of a new border is an exciting prospect this time of year. Whether it be to enhance and deepen the planting scheme or as a cut flower bed, the opportunities at the beginning are limitless – if we allow it. The first thing I consider is the light, the one thing you cannot change is the sun so we must work with it. The next thing to consider is context – by this I mean what does it line up with, does its curve move and join the curve of another bed, does the movement around the bed allow for a 'natural flow' around the garden? I like to draw it out – many times and then use line marker to mark it out.

My one piece of advice is – go big! Most designs don't have an impact because they have been too cautious. I know this sounds like I'm asking everyone to be open to an RHS show garden but that is not the case – a 20l shrub instead of a 3l shrub, a small tree instead of a pot of geraniums – it makes all the difference.

At the end of the day, it is a garden to enjoy and have fun in – so have fun with it!

The Tudor Gardener



GENERAL LIEUTENANT KARL VON GRAFFEN

On Monday 11th May at 1900 in Droxford Village Hall, the author Angela Findlay will present *"In My Grandfather's Shadow"*. A cash bar will be available from 1830, and supper (£17.50 a head payable in cash) will be available after the talk. Non-members are very welcome to attend. Those wishing to take supper, please contact robmunroscott@aol.com at least a week beforehand. The talk itself is free of charge but donations to the RBL are always welcome.

In My Grandfather's Shadow, Angela Findlay explores her search for understanding and reconciliation with her family's past. Angela delves into the legacy of her German grandfather, *Generallieutnant* Karl Von Graffen, who served as an officer in Nazi Germany's *Wehrmacht* during the Second World War. Through personal reflection, historical research, and poignant storytelling, Angela examines the complexities of inherited guilt, the impact of war across generations, and the importance of addressing uncomfortable truths.

Angela's story weaves together her journey to Germany, her discovery of family secrets, and her exploration of art as a means of healing. It offers a deeply moving perspective on identity, forgiveness, and the enduring effects of history on individuals and families. *In My Grandfather's Shadow* is testament to the power of confronting the past to build a more compassionate future.

Karl von Graffen (1893 -1964) was a highly decorated German general who held divisional and corps level commands during the 2nd World War. He was a recipient of the Knight's Cross of the Iron Cross. As Commander of LXXVI *Panzerkorps*, he was taken prisoner in May 1945 by the US 85th Infantry Division near Belluno, Italy, and was released in March 1948.

Angela Findlay is a professional artist who has spent much of her career teaching art in prisons. Her time 'behind bars' in Germany and later as Arts Coordinator to the Koestler Arts charity inspired her research into intergenerational trauma and, over the last decade, she has been speaking and writing about trauma, guilt, cultures of remembrance and her own Anglo-German roots.



The RBL Droxford & District Branch is always looking for new members, both Service and civilian, to help keep remembrance alive and support our Servicemen and women, veterans and their families. For more information or to join us, please contact the Secretary – Cdr Rob Scott RN at robmunroscott@aol.com or 01489 877800. www.soberton.org/rblweb.



POP IN FOR COFFEE AND CAKE

at ST PETER'S CHURCH ROOM, SOBERTON

POP IN FOR COFFEE & CAKE ON THE 2nd & 4th WEDNESDAY EACH MONTH

10am – noon

MEET FRIENDS, MAKE NEW FRIENDS AND HAVE A CHAT!

Atlantic salmon's long journey back to the River Itchen

Atlantic salmon have one of the most remarkable life cycles in the natural world. Born in the clean gravels of rivers like the River Itchen, these powerful fish travel thousands of miles across the Atlantic Ocean before returning, often years later, to the very same stretch of river where they began life.

For thousands of years this migration has been part of the natural rhythm of the Itchen. Each year young salmon head out to sea, growing to adulthood in the North Atlantic before navigating their way back to the chalk streams of southern England. Their return is one of nature's most extraordinary journeys, guided by instinct and an ability to detect the unique chemical signature of their home river.

Atlantic salmon are among the most recognisable fish in British rivers. Adults returning from the sea are powerful, streamlined fish with silvery flanks, dark speckles along their backs and a forked tail built for endurance swimming. Some can grow over a metre long. During the spawning season their appearance changes as they adapt to freshwater, often darkening in colour while males can develop a distinctive hooked jaw.



Photo: Linda Pitkin 2020VISION

After returning from the ocean in winter, females dig shallow depressions in clean gravel known as redds, where they lay thousands of eggs. Redds appear as lighter patches of gravel with a shallow dip and mound. The eggs remain buried in the gravel until they hatch in late spring. However, these nests are fragile and easily damaged by disturbance in the river such as wading, wild swimming, paddling, and dogs entering the water. Any activity that disturbs the riverbed can crush the eggs or compact the gravel around them, cutting off the oxygen they need to survive. Members of the public can help protect this vulnerable stage in the salmon's life cycle by keeping to the riverbanks and staying out of the River Itchen.

Atlantic salmon are uniquely adapted to their home rivers. Chalk stream salmon populations are genetically distinct, shaped over thousands of years by the conditions of the rivers they return to. The River Itchen is one of only six chalk streams in England that still supports wild Atlantic salmon.

However, their numbers have fallen dramatically. In 2022, just 133 adult salmon were recorded returning to spawn, and numbers remain critically low. This decline has prompted conservation organisations, including Hampshire & Isle of Wight Wildlife Trust, to launch the Itchen Salmon Delivery Plan, a coordinated effort to restore habitats, improve water quality and remove barriers to migration.

For more information about this iconic species, please visit the Hampshire & Isle of Wight Wildlife Trust website: hiwwt.org.uk/news/urgent-action-launched-save-endangered-atlantic-salmon



**Hampshire &
Isle of Wight
Wildlife Trust**

Hampshire & Isle of Wight Wildlife Trust manages nature reserves, including those which the River Itchen flow through.

If you would like to help support the Trust's conservation work to help species including the

Atlantic salmon, please consider joining the Trust as a member from £2.25 a month.

Membership includes Wild Magazine three times a year. Visit: hiwwt.org.uk/join-today or call 01489 774408.



THE UNIVERSITY OF THE THIRD AGE

Meon Valley U3A continues its lecture programme for April /May 26. We meet every first and third Tuesday at 2pm

On 7/4 Jacqueline and Brian Sutton offer us “**The Duke of Monmouth-How he lost his head**”. After a very successful first visit they return to educate us again.

On 21/4 our own Mike Hollis will talk on “**The Birth of Civilisation**”.

We continue on 5/5 with our very short AGM(!) followed by Don Bryant talking on “**Archaeological Divination**”. This is a fascinating lecture with live evidence of how divination works for Archaeological discovery and not just to find a water source.

We then stop for the summer and start again in September.

Our venue is now Our **Lady Queen of Apostles Church Hall at Martin Street Bishops Waltham SO32 1DN**, where we have settled in well.

Everybody is welcome. Guests will get an especially warm welcome. (Guests pay £2 to defray speaker costs.) Tea and biscuits are provided after the talk, and we always have pre-loved books for charitable sale.

Lyndon (programme organiser)
Contact-07881991763
Or lyndonplmr@gmail.com
Web site:- southeast.u3asite.uk

INTERESTED IN THE ARTS?

In 2026 join us to explore topics ranging from Viking Mythology to Monopoly, art and culture in Vienna, Kosovan Silver Jewellery and the work of Henry Moore. Decode country house portraits & the English Garden.



Come along to The Meon Valley Arts Society
(a branch of The Arts Society (a worldwide organisation))

Monthly Lectures / Special Interest Days / Visits & Social Events

We have supported community arts projects in local schools, Guides and Beavers, Bishops Waltham Gateway Club and Swanmore Amateur Dramatic Group.

Join us at The Meon Hall in Meonstoke on the second Tuesday of each month when we enjoy lectures from first class speakers

Refreshments are served from 10.00 am. Lectures start at 10.40 and finish by noon.
Day membership £7

See our website for more information.

www.mvdfas.org.uk



Local Government Reorganisation (LGR) and Mayoral Combined County Authority.

By way of an update the Parish Council understands that LGR elections will take place in May 2027 for the new unitary authority, once elected will take over the role of the District Council's, in our case Winchester City Council, after a transition period. The new unitary authority will cover a larger population and area than the existing City council and it seems there will be fewer councillors, where at present we have three District Councillors covering our Parish we will probably have one. In other parts of the country where LGR has taken place parishes have clustered together to form Local Area Committees these seem to be based on population rather than area. This will be an option for the PC to consider in a year or so once the new unitary authority is established.

The difficulty we can all see is local representation for local issues however, the counter argument is efficiency. We live in an age where communication is almost instant certainly supporting the vulnerable, elderly and digitally excluded will be tested. It is clear that any change will need to be carefully managed.

Hampshire County Council Elections

The Parish Council understand the election for the Hampshire County Councillor for the Hampshire Southern Parishes will be held on 7th May. Confirmation and details will be published at the end of March (this column is written in mid March)

Parish Council Elections 7th May 2026

Soberton Parish Council will be held on the 7th May for both XU and XT polling areas of the parish. A list of candidates for each polling area will be displayed on the parish notice boards, on the parish website and relevant social media in mid-April.

Nomination papers for candidates are available from the Parish Clerk, the closing date for 3rd - 6th April 2026

Tree Survey and Maintenance Works

The Council has recently appointed a contractor to carry out a tree survey across Parish Council owned property. The survey identified several trees on the Recreation Ground and around the Chapel Road Pond that require maintenance work. These works will be undertaken over the coming months to ensure the trees remain safe and well managed.

New Parish Council Website

New compliance legislation has recently come into force, requiring the Parish Council to review how we communicate with residents. As part of this, we have launched a brand new website. The website will help residents stay up to date with Council news, activities and important local information.

Visit the new website at: www.soberton-pc.gov.uk

General advice regarding Cesspits

James Hucklesby Environmental Health Protection WCC

- Cesspits require, on average, emptying every six weeks by a licensed waste contractor to prevent illegal and hazardous overflows, with frequency depending on their size and the household size. They are sealed, non-treatment tanks that must never receive chemicals, fat, or non-biodegradable items as this can damage them. Key Cesspit Maintenance and Advice
- Frequent Emptying: Because they do not treat sewage and only store it, cesspits fill rapidly and require regular, professional emptying (often every 4-6 weeks). Letting them overflow is an offence under the 1936 Public Health Act.
- What to Avoid (No-Nos): Do not flush anything other than toilet paper and human waste. Never pour cooking oil, grease, paint, solvents, or hazardous chemicals down drains, as these cause blockages and damage the tank.

- **Cleaning Products:** Use biodegradable, eco-friendly household cleaners to avoid damaging the environment if a leak occurs.
- **Safety Precautions:** Never open or enter a cesspit tank; dangerous gases are produced by the decomposing waste.
- **Site Access:** Ensure the area around the manhole cover is easily accessible for tanker vehicles.
- **Water Conservation:** Limit water usage to prevent the tank from filling too quickly.
- **Legal and Operational Requirements** Only use a registered waste disposal company for emptying. Keep a record of all maintenance and emptying services.

Do not discharge/empty your cesspit into ditches or watercourse

John Hyland
Chairman
chair@soberton-pc.gov.uk

SOBERTON PARISH COUNCIL - COUNCILLORS

JOHN HYLAND - CHAIRMAN	chair@soberton-pc.gov.uk
NEIL FINDLAY - VICE-CHAIRMAN	vicechair@soberton-pc.gov.uk
DAVID CLEEVE	Cllrcleeve@soberton-pc.gov.uk
SAM MARLAND	Cllrmarland@soberton-pc.gov.uk
PAUL HENDERSON	Cllrhenderson@soberton-pc.gov.uk
JOHN RUSSELL-SMITH	Cllrrussell-smith@soberton-pc.gov.uk
JONTY SHERWILL	Cllrsherwill@soberton-pc.gov.uk
VICKI WESTON	Cllrweston@soberton-pc.gov.uk
DAVID BUTTRISS	Cllrbuttriss@soberton-pc.gov.uk
KATE BUTTRISS	Cllrkbuttriss@soberton-pc.gov.uk
CAROL WILLIAMS	Cllrwilliams@soberton-pc.gov.uk
CLERK AND PROPER OFFICER	clerk@soberton-pc.gov.uk

Earlybirds Needs Your Tesco Blue Token Vote!



Earlybirds (your local Newtown and Soberton charity Preschool) is very excited to share that our application to the Tesco Grants Programme has been successful, and our breakfast club project will be put forward to a customer vote in Tesco stores (via the blue token charity boxes).

Voting will commence in store from Tuesday 28th April 2026 until the end of July 2026 in the following stores:

- Portchester Express: PO16 9UZ
- Fareham Superstore: PO16 0LE

The project with the highest number of votes across our region will receive £1500, second place £1000 and third place £500.

To vote, you will need to make a purchase within store of any value. You will receive one token per transaction, and it's not necessary to purchase a carrier bag in order to receive a token.

Help us to provide a healthy breakfast and enriching activities to our youngest learners, helping them to grow, explore, and thrive – we would be so incredibly grateful for your support.

For more information, please contact the Earlybirds Team:

earlybirds16@hotmail.co.uk

07701259985

Hampshire & Winchester Councillor Update

– The Wider Role of a Councillor

Most people encounter their local councillor when something very visible needs attention — a pothole, a planning concern, or a local service issue. But a great deal of a councillor's work happens behind the scenes, in roles that are less well known but essential for keeping councils effective, transparent and responsive to the needs of residents. This month I'll take a look at some of my wider responsibilities across Hampshire and beyond.



A varied role across many committees

As a councillor I am member of a wide range of committees, panels and working groups, each dealing with different aspects of local government. These include scrutiny boards that examine public service decisions, finance and audit panels that oversee budgets and risk, and strategic groups that look at emerging challenges for the county. Although the subjects vary widely, the purpose is the same: ensuring openness, accountability and well-informed decision-making on behalf of local communities.

Looking to the future – long-term planning and climate work

The Hampshire 2050 Committee is a group within Hampshire County Council that looks closely at how the council plans for the future. Working groups, for example on climate change and sustainability, bring together councillors with officers, specialists and community partners to consider long-term challenges. These discussions help shape policies that will guide the area over the coming decades.

Overseeing financial stewardship

Financial oversight is another key area where councillors play an important role. Audit committees review how public money is managed, assess financial reporting, monitor internal controls and examine risk management processes. This work is essential for maintaining transparency and public confidence, particularly during periods when local government finances are under pressure.

Protecting local rivers and the natural environment

Through my role on the River Hamble Management Committee, I have been exploring ways to mitigate the environmental impact of M27 run-off entering the River Hamble. Run-off from the M27 bridge over the River Hamble has long been recognised as an environmental concern, as water draining from the road surface can carry microplastics from tyre wear, heavy metals, hydrocarbons and fine sediments directly into the river. These pollutants pose risks to the Hamble's sensitive habitats, which form part of the Solent Maritime Special Area of Conservation and Special Protection Area. Working with other local stakeholders (including Hamble Valley MP Paul Holmes) we are seeking assurances that the opportunity to address pollution from the outfalls will not be missed, to help safeguard water quality and the wider marine environment.

Standing up for communities through provider scrutiny

Councils also work with utility providers through independent challenge groups or advisory panels. These groups scrutinise issues such as water supply resilience, leakage reduction, and customer communication. Recently I have been working with Portsmouth Water on their stakeholder engagement strategy, and on improving processes for identifying responsibility for leaks.

Though much of this work happens quietly, it helps keep services effective and communities well-supported — a reminder that the role reaches far beyond the issues we see day to day.

Cllr Malcolm Wallace, malcolm.wallace@hants.gov.uk

Cllr Danny Lee, dlee@winchester.gov.uk

Cllr Suzanne White, swhite3@winchester.gov.uk

Malcolm with a representative from the Final Straw Foundation, which has prepared and released more than 10,000 native oysters into Solent marinas, including the River Hamble, to help restore and strengthen local breeding populations.





FAREWELL and THANK YOU

After serving the community of Soberton and Newtown for 14 years, as a Hampshire County Councillor, I have decided to retire from local government and am not seeking re-election in May. This means that you will not receive any future HCC reports from me in the Parish Magazine and soon you will be electing my successor.

I have always tried hard to represent you and your views, to help resolve any problems you may have had and to keep you informed about sources of help and support. My casework has been extremely interesting, very varied and sometimes quite challenging, but it's always been rewarding to help people.

Thank you for your help and support during my long tenure as a local authority Councillor, it is appreciated more than words can express in this short article.

And don't forget, the drop-in Councillor Surgery continues on the first Saturday of every month, 10.00 am - 12 noon [no appointment necessary], The Heath Room, All Saints Church, Denmead.

With all good wishes and grateful thanks.

Patricia Stallard
Hampshire County Councillor
Winchester Southern Parishes

Winchester Southern Parishes

Newlands, Denmead, Southwick, Boarhunt, Wickham, Knowle, Soberton, Newtown

Thank you, Patricia, for your many years of dedicated service, and we wish you a very happy and well-deserved retirement.

Wickham Society Spring Programme 2026

Meetings are held at the Wickham Community Centre starting at 7.30 pm. Membership is £8 per annum or £2.50 for an occasional visitor. New members and visitors are always welcome.



14 April 2026

Wickham in Bloom

Learn how our entry achieved Gold in 2025 and the plans for 2026!

Heather Reid,

Chair of Wickham in Bloom

12 May 2026

Wyches Vineyard

Hear about the rewards and challenges of running a local vineyard

Tony Burton,

Director of Wyches Vineyard

For more information visit our website or contact

wendy.greenish@gmail.com or 01329 833583

www.wickhamsociety.org.uk

Please e-mail copy for the June / July magazine to
gill.highcroft@btinternet.com
NEXT COPY DATE - 11th May 2026 (17:00)

Meon Valley Carers Group

For carers of someone with Dementia
Receive support, information and signposting
Meet and talk to others carers in similar situations

4th Tuesday of each month 2pm - 4pm

at The Paterson Centre, Church Road, Swanmore, SO32 2PA

The programme for these meetings is varied with speakers ranging from necessary, interesting, factual information to more lighthearted subjects.

Built into the group meetings are arts and crafts, musical afternoons and games suitable for those living with Dementia.



You will be given a warm welcome!



Tea coffee and biscuits provided

Free parking in the car park opposite the Paterson Centre

For more information, please contact

Allison McNally

tel: 07771 895370

e-mail: allison.mcnally1968@gmail.com



MEON VALLEY BOWLING CLUB BISHOP'S WALTHAM

WELCOMES EVERYONE



OPEN DAY!

SATURDAY 18TH APRIL 2026

TRY IT
FOR FREE

VISIT OUR GREEN
AND START
BOWLING!



Our qualified coaching team will be available with details of our 2026 beginners' course

Why not try a new activity?

Based at Priory Park, Bishop's Waltham
It's at the top of Elizabeth Way, off Victoria Road, Bishop's Waltham
SO32 1SQ

To book your place
Email: pduckmanton8@gmail.com
Tel: 07734320418

Visit www.meonvalleybowlingclub.chessck.co.uk for further information in the section marked: "OPEN DAY"

MEON VALLEY HEARTSTART UK

Meon Valley Heartstart are a small and friendly group of volunteers providing free training sessions on how to save a life



We teach CPR, how to use a defibrillator and more!

Could you spare a little time each month to help us?

We have various positions available including;

Lead trainer
Admin support
Equipment coordinator
Course Assistants
Medical Support Coordinator
Fundraisers



To register interest or for an informal chat, contact David on 07730 148920 or email info@heartstartmeonvalley.co.uk

www.heartstartmeonvalley.co.uk

Guest Speaker
Ian Howard:
"The Truth is
Black and White"

Thursday 4th June 2026 at 7:30pm



Ian's talk will give an overview of the theory of black & white photography along with tips and advice on processing and presenting images, including the journey of several images from the initial RAW image, to the final black & white version. Ian will also discuss the various "ideal" black & white subjects areas.



Bishop's Waltham
Photographic Society

St Peter's Church Hall, Free Street, Bishop's Waltham, SO32 1EE

Non-members are welcome (entry fee £5).

bishops-waltham-photosociety.co.uk

Mayor of Winchester's Community Awards

You have mail! And the email started ... *Invitation to the Awards Ceremony – Thursday 12th March 2026.* On behalf of the Mayor of Winchester and Winchester City Council, I am delighted to tell you that you have been nominated to receive a Mayor of Winchester's Community Award for service to the people of the Winchester District, Further to your nomination by ...

A few weeks ago, this email was received by a few people who live in and/or support activities in Soberton and Newtown. What a pleasant surprise!

Soberton Parish Council put forward Gill Gray (yes, the editor!) for her contribution to village life as editor of the parish magazine since 2019 together with her involvement in the Newtown Church Fete, Messy Church and Children's Week. They also nominated Sue and Fra Wells for their years of support to the Newtown Church Fete and their ongoing generosity of opening their garden and grounds to the Fete and its visitors very year. Congratulations to Gill, Sue and Fra! A big thank you to Neil Findlay, Soberton Parish Council, Vice-Chairman for coming along to the ceremony to support the SPC nominees.



Gill Gray



Carol Munday (3rd left)

Congratulations to Carol Munday was awarded an award with The River Meon Conservation Volunteers who work with SDNPA, HIWWT, landowners and fishing and river enthusiasts to protect and enhance the River Meon, one of only around 200 chalk streams in the UK. The group clear vegetation, improve habitats and conduct citizen science projects to gather vital data on water voles and key invertebrates,

Our congratulations also go to ACSO Sarah McCulloch with a lovely citation highlighting how she is made for community work and consistently goes above and beyond. She is exceptionally committed in her support of the most vulnerable and at-need with her success being rooted in building relationships and earning trust – she is widely respected by all colleagues and residents.

All award winners received a certificate, lapel pin and a photo, with the Mayor of Winchester, Councillor Sudhakar Achwal. There was a lot of pride and warmth in the room and it was humbling to hear about the efforts of so many, young and old alike – some absolutely amazing contributions by so many committed volunteers.

Our congratulations to them all!



ACSO Sarah McCulloch

Photos: Nigel Kenny
Simply Event Photos

MEON VALLEY LIONS CLUB



Dates for your diary

Saturday 18th April Wickham Charity Beer Festival

Saturday 2nd May Dementia Concert (Bishop's Waltham Jubilee Hall)



www.meonvalleybus.co.uk
info@meonvalleybus.co.uk

Timetable from July 2025

Mondays West Meon to Fareham

0930	West Meon Thomas Lord PH
0933	Warnford Village Hall
0938	Exton The Shoe PH
0940	Meonstoke PO & Stores
0944	Meonstoke Pound Cottages
0951	Droxford Square
0955	Brockbridge The Hurdles
1000	Soberton Village Hall
1003	Webbs Green War Memorial
1006	Soberton Heath Chapel Road Pond
1008	Soberton Heath Bold Forester PH
1010	Newtown Rookesbury Hall
1015	Hundred Acres
1027	Fareham Library
1032	Fareham Station <i>Drop off only*</i>
1039	Fareham Sainsbury's
Return:	
1230	Fareham Sainsbury's
1235	Fareham Library

Wednesdays Soberton to Petersfield

Including all request stops on A32 Droxford- West Meon

0930	Soberton Village Hall
0934	Brockbridge (The Hurdles)
0939	Droxford Square
0946	Meonstoke Pound Cottages
0951	Corhampton
0954	Warnford George and Falcon
1013	Petersfield Station <i>Drop off only*</i>
1017	Petersfield Square
1022	Petersfield Tesco
Return:	
1225	Petersfield Tesco
1230	Petersfield Square

Fridays Soberton to Winchester

0930	Soberton Village Hall
0934	Brockbridge The Hurdles
0939	Droxford Square
0945	Meonstoke Pound Cottages
0949	Meonstoke PO & Stores
0951	Exton The Shoe PH
0956	Warnford Village Hall
1016	Winchester Broadway
1023	Winchester Station <i>Drop off only*</i>
1030	River Park Leisure Centre
Return	
1225	River Park Leisure Centre
1230	Winchester Broadway

No service on other days or public holidays. £6 return, £3 single any journey. Bus passes accepted. Under 16 half fare. Under 5 free. Dogs allowed subject to driver discretion. Timings are strict, bus will not wait after scheduled time.

A FEW USEFUL NUMBERS

ANY ADDITIONS OR CHANGES, PLEASE CONTACT THE EDITOR

SOBERTON VILLAGE HALL BOOKING		sobertonvillagehall@googlemail.com www.sobertonvillagehall.co.uk 01329 834392
ROOKESBURY HALL BOOKING	Jenny Doney	Bookings@rookesburyhall.co.uk 01489 877430
GUIDE HUT BOOKING	Caroline Rogers	guidehutsoberton@gmail.com 07843 496852 07710 716664
GOOD NEIGHBOURS GROUP <i>OFFERS TRANSPORT TO MEDICAL APPOINTMENTS</i>	Kate Harvey Kate Chesters	See page 5 for more details 07442 156124 acso@swanmore.org.uk
COMMUNITY SUPPORT OFFICER	Gary McCulloch ACSO	
CLERK AND PROPER OFFICER	clerk@soberton-pc.gov.uk	See page 41 for full list of Councillors
CENTRAL MEON VALLEY COUNCILLORS	Malcolm Wallace Danny Lee Suzanne White	See page 42 for contact details
COUNTY COUNCILLOR		Pending election

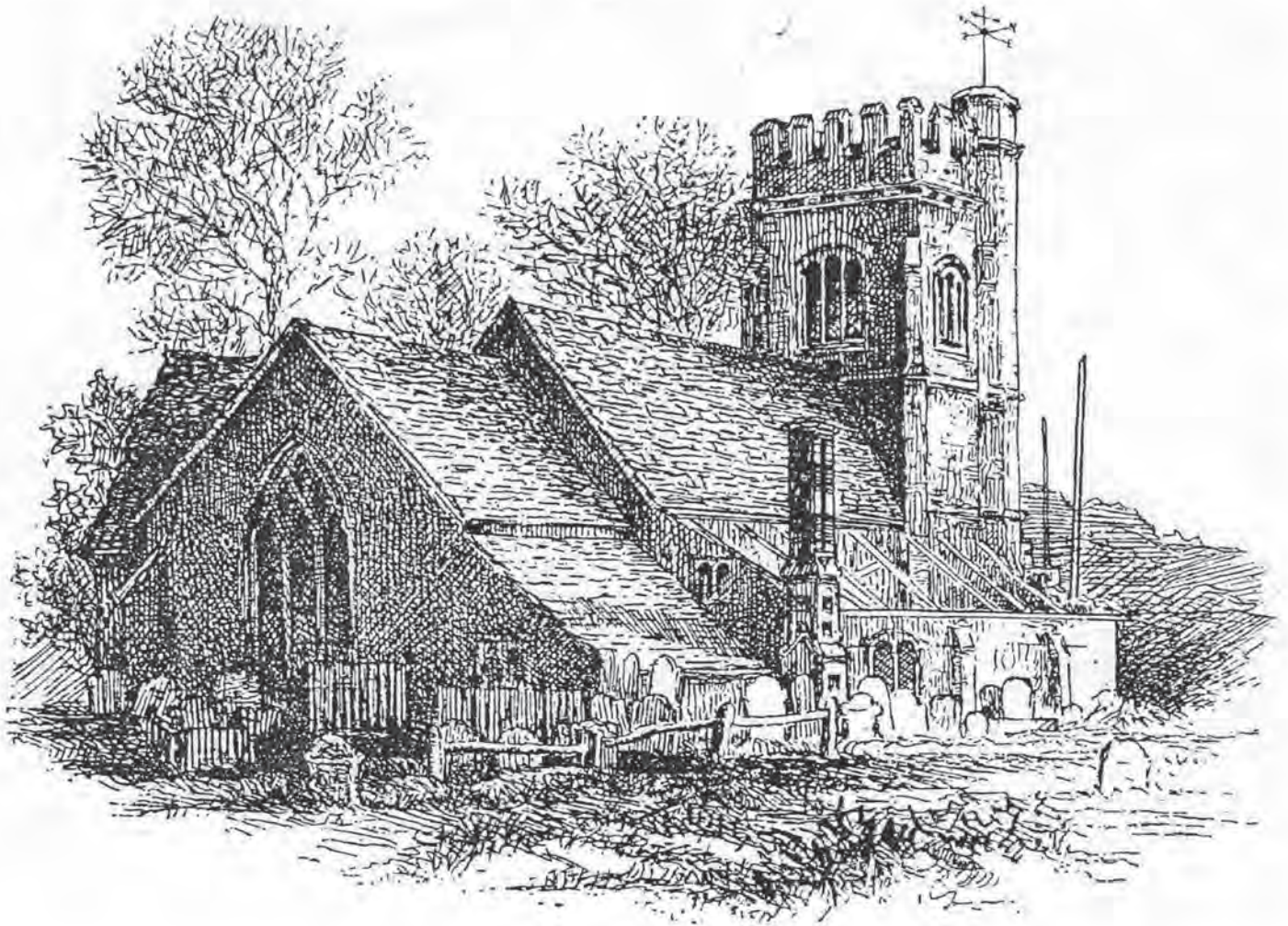

Above - This is the drawing from the appeal of the 1880's for funds for the restoration of St Peter's Church, which was in a bad state of repair. Note the roofless North Aisle. See the article on pages 34/35 for more information.

Below - An extract taken from the appeal giving details of donations secured. Interestingly, £500 in postage stamps which is a huge amount for the time. The donations from butlers and servants was driven by a story that the Tower was built by a dairy maid and butler due to carvings of a bucket (or purse) and a key.

SOBERTON CHURCH RESTORATION.

Will you kindly send a little help to a very poor Agricultural Parish?

Having no resident Gentry, we can only hope to complete our work by the help of generous friends of the Church, and those who take an interest in footprints of the past.

£1,800 is required to *restore* and *reseat* the Church.

£1,500 has been secured. Including donations from :-

The LORD BISHOP OF WINCHESTER	... £25 0 0	Proceeds of Bazaar in Soberton £120 0 0
The Right Hon. SCLATER-BOOTH, M.P.	... 5 0 0	Donations from Butlers and Servants towards	...
CARPENTER GARNIER, Esq., M.P.	... 10 0 0	Special Tower Fund	... 70 0 0
W. W. BEACH, Esq., M.P.	... 5 0 0	Received in Postage Stamps, about	... 500 0 0

The Church is falling into decay; rain comes in through the roof, the tower has been pronounced unsafe, and the interior of the building is in an equally dilapidated condition.

(from the Archives of the Soberton & Newtown Local History Society) any additional information is always welcome.

Please Contact lyndonplmr@gmail.com or petewoodacre@gmail.com



andrew & andrew

solicitors

FOR TRUST. FOR ADVICE. FOR LIFE.



WICKHAM

11, The Square, Wickham, Fareham,
Hampshire, PO17 5JQ
Tel: 01329 623 322

PORTSMOUTH

Atlantic House,
114 Kingston Crescent,
Portsmouth, PO2 8AL
Tel: 023 9267 5555

EMSWORTH

51 High Street,
Emsworth,
PO10 7AN
Tel: 01243 680 800



OUR SERVICES



Wills,
Probate,
Powers of Attorney



Family Law/
Matters



Residential
Conveyancing



Personal
Injury



Contentious
Probate



Employment
Settlement
Agreements