

Soberton & Newtown

PARISH MAGAZINE For all the community, delivered FREE to over 700 households

June - July 2026



Cover design: Jonty Sherwill

Celebrating Anthony and Louise McEwen's
contribution to the Soberton community
24th April 2026
Photo by Jonty Sherwill

www.sobertonchurch.org.uk
www.newtownchurch.org.uk

St. Peter's, Soberton and Holy Trinity, Newtown

For details of Benefice and other local church services, please refer to page 4

Benefice of Soberton, Newtown and Hambledon

The Reverend Liz Quinn, Associate Priest in the Meon Valley Parishes.

Particular focus on the Benefice of Soberton, Newtown and Hambledon.

revliz7@icloud.com 07518 247637

Barn Church

Emma Andersen, leader of Barn Church.

Associate Priest in the Meon Valley Parishes emma.barnchurch@gmail.com

Our Lady Queen of the Apostles, Roman Catholic Church

St. Martin's Street, Bishop's Waltham, SO32 1DN

Father Mario Toma 02380 612430

Parish Office 02380 273882

18.00 Saturday (First Mass of Sunday)

09:30 Sunday (There are Sunday evening services in Winchester and in Fareham.)

Meon Valley Methodist. All services at 10:30.

Shirrell Heath / Waltham Chase / Bishops Waltham / Swanmore / Hambledon

Soberton and Newtown Church contacts

Any additions or changes, please contact the editor

Newtown Church Warden	Fra Wells	01329 834130
PCC Secretary	Malcolm Padgett	01329 834684
Parish Safeguarding Officer	Caroline Barfoot	htn.safeguarding@gmail.com
Soberton Church Warden	-	-
Parish Secretary Contact	Jackie Hunt	07940 649691
Parish Safeguarding Officer	Wendy Prangnell	Stpc.safeguarding@gmail.com
Captain Of Bells	Caroline Rogers	01489 877430
Churchyard Keeper	John Lester	01489 878557

MAGAZINE COMMITTEE & PRODUCTION TEAM

Chairman	Perry Abbott	02392 632338	cpgabbott@hotmail.com
Editor	Gill Gray	07711 058760	gill.highcroft@btinternet.com
Advertising	Kate Buttriss	07801 441998	kate.buttriss@gmail.com
Circulation	Pete Woodacre	01489 877768	petewoodacre@gmail.com
Treasurer	Jerry Lipscombe	07899 862235	lipscoj3@gmail.com
Secretary	Vacancy		

Typesetting of adverts and printing: Solent Design Studio solentdesignstudio.co.uk

Front cover design: Jonty Sherwill 01329 835161 www.sherwilldesign.com

Contents

4	❖ The Benefice of Soberton, Newtown & Hambledon – Services
	❖ Barn Church
	❖ Pop in for coffee and cake at St Peter's
5	❖ Soberton Fete 2026
6	❖ A thank you party for the McEwens – and what fun it was!
	❖ Soberton Players – play reading evenings
7	❖ Soberton Players – auditions for Robin Hood – the panto
8	❖ Droxford Junior School
	❖ BW Photographic Society – junior and youth photographic competitions
9	❖ Children's Week 2026
	❖ Earlybirds Needs Your Tesco Blue Token Vote!
10	❖ SoberNewts - Volunteers clock up 550 hours of work for nature
	❖ Children's Sunday Club
11	❖ In Memory of John Rowlinson
	❖ Money for Youth
12	❖ The Guide Hut - Annual Report 2026
12/13	❖ Brownies Annual Report – April 2026
13	❖ Guide's Recap
14	❖ Soberton and Newtown Ladies' Group
	❖ Segalula – Look on the Bright Side
	❖ Rookesbury Hall – dates for your diary!
15	❖ Soberton club players win the Portsmouth Stannard Shield
16-31	❖ Classified Adverts – please support our local businesses
32	❖ Soberton and Newtown Good Neighbours Group
33	❖ What's on / contact numbers – local clubs and interest groups
34/35	❖ Local History ... A Midnight Murder at Hambledon
35	❖ Soberton & Newtown Local History Society
36	❖ Meon Valley Garden Club Summer Show
37	❖ In your garden ... muck management
38	❖ RBL - Droxford & District Branch
39	❖ June, July and a thank you to Paula
40/41	❖ Soberton Parish Council: Annual Parish Report 2025-2026
42	❖ Winchester Councillor Update – Local Government Reorganisation
43	❖ The cuckoo is back (Hampshire & IoW Wildlife Trust)
44	❖ Meon Valley Carers Group / Meon Valley Heartstart / BW EatSTreat / BW Photographic Society
45	❖ BW Give & Take / MVARA on the road! / Meon Valley Lions Club
46	❖ Meon Valley Community Bus Timetable
	❖ A few useful numbers
47	❖ From the Archives
Back page	❖ Classified Advert – please support our local businesses

**Please e-mail copy for the August / September magazine to
gill.highcroft@btinternet.com**

NEXT COPY DATE - 20th July 2026 (17:00)

Services

The Benefice of Soberton, Newtown & Hambledon

June 2026
July 2026

*Holy Communion is also
celebrated at Soberton at
09:30am every
4th Wednesday (before
coffee and cake)*

*and at Hambledon every
Wednesday at 09.30.*

*Subject to change,
sometimes at short notice*

June				
7 th	0800	Holy Communion	Hambledon	
	1000	Holy Communion	Newtown	
	1030	Short Family Service	Hambledon	
14 th	1100	Holy Communion (Sunday Club)	Soberton	
	1100	Service of the Word	Hambledon	
	1830	Taize	Hambledon	
21 st	1000	Holy Communion	Newtown	
	1100	Holy Communion	Hambledon	
	1830	Evensong	Hambledon	
27 th		Soberton Fete – prayers in the church	Soberton	
28 th	1100	Holy Communion/BBQ/Family Day	Hambledon	
July				
5 th	0800	Holy Communion	Hambledon	
	1000	Holy Communion	Newtown	
	1030	Short Family Service	Hambledon	
12 th	1100	Holy Communion (Sunday Club)	Soberton	
	1100	Holy Communion	Hambledon	
19 th	1000	Holy Communion	Newtown	
	1100	Morning Worship	Soberton	
	1100	Service of the Word	Hambledon	
	1830	Evensong	Hambledon	
26 th	1100	Holy Communion	Hambledon	
	1800	Holy Communion	Soberton	



The dates for the Barn Church services for June/July are:

Sunday 7th June	9:30am Soberton Guide hut
Sunday 14th June	9:30am Soberton Guide Hut
Sunday 21st June	9:30am Soberton Guide Hut Barn church BASH (bring & share breakfast)
Sunday 28th June	9:30am Soberton Guide Hut
Sunday 5th July	9:30am Soberton Guide Hut 2:30pm Family Walk, Woodend Car Park
Sunday 12th June	9:30am Soberton Guide Hut
Sunday 19th July	9:30am Soberton Guide Barn church BASH (bring & share breakfast)
Sunday 26th July	9:30am Soberton Guide Hut

We now run 3 midweek Groups where we are growing together in community, developing a deeper connection with God and championing each other through life. Our Groups are on Sunday, Tuesday or Wednesday evenings and meet in homes. If you'd like to join a group please email Rev Emma Andersen emma.barnchurch@gmail.com

POP IN FOR COFFEE AND CAKE

at ST PETER'S CHURCH ROOM, SOBERTON

POP IN FOR COFFEE & CAKE ON THE 2nd & 4th WEDNESDAY EACH MONTH

10am – noon

MEET FRIENDS, MAKE NEW FRIENDS AND HAVE A CHAT!



SOBERTON FETE

27TH JUNE

SATURDAY, 1.30 PM

(GATES OPEN AT 1.00 PM)

**FOOD & DRINK, ENTERTAINMENT,
GRAND DRAW AND MUCH MORE!**

**CHURCH GREEN,
SOBERTON, SO32 3PF**

**ADULTS £2 CHILDREN UNDER 12 FREE
STALLS ARE MAINLY CASH ONLY
CASH MACHINE ONSITE**

A thank you party for the McEwens – and what fun it was!

On 24th April, over 100 villagers joined together in Soberton Village Hall for a fantastic, fun evening and the opportunity to thank Louise and Anthony McEwen for their massive contribution to village life since they moved to Soberton in 1983.

Central and well-known figures locally, Louise and Anthony are both endlessly warm, welcoming, kind and community-minded and have spent more than four decades strengthening Soberton's social fabric, supporting its institutions, and caring for its people. Many readers will know about their many and varied activities, but for those that don't, here's a flavour (and it's most certainly not an exhaustive list!). Please forgive any omissions!

Anthony – advertising manager for this magazine (and treasurer for a while!), maintenance of St Peter's grounds, Royal British Legion, chair at one point, supporting elderly and retired naval personnel, leading the Remembrance Service, started supper clubs, organised tennis knock out competitions, tug of war at Soberton Fete, passionate about the River Meon and, also, the mayfly ... and and and ... !

Louise – Brown Owl, Church Warden at St Peter's, created and lead two teams for church cleaning and flower arranging, Messy Church, Children's Week, church choir and other musical activities (voice like an angel!), founded Stitch and Chatter, supported neighbours in times of illness and bereavement, ran the annual reeling party (hampers), household and gifts at Soberton Fete ... and and and ... !

As to the party – what an evening! A bring your own supper and drinks – best buffet ever, as one would expect from our local community! The hubbub ... high decibel chatting as everyone caught up with friends and neighbours and, of course, Anthony and Louise! A great speech by Jonny Buckley, summarising their life and times ... everyone present found out something about the McEwens that they didn't already know! Anthony responded – short and sweet, but as warm as ever.

And then, off they went in a flying rickshaw, modelled as a mayfly and pushed by tennis buddies! Hard to explain - you had to be there – but it was great fun and Louise and Anthony clearly enjoyed every second! What fun!!

Whilst they are moving away, hopefully they won't be going too far and their friendships and village links will remain – thank you both for your massive contribution to village life! As well as all they have done over the years, their legacy has to be that most of what they started still runs ... a testament to their energy and ability to get others involved!

A big thank you to Richard and Pru Bell-Davies for organising such a lovely party – it was great!



SobertonPlayers

Play Reading Evenings

Have you ever fancied diving into the character of a play but are put off by the prospect of acting on stage? Play readings are a great way of taking part in a story, without the pressure.

Over the summer we'll be holding a series of informal get-togethers in the Village Hall where we chose a script, divide up the characters and allow everyone to unleash their inner Colin Firth or Kate Winslett. No preparation or learning of lines necessary.

The dates for the first couple of play readings are below. Do come along – they are great fun.

June 4th, 2026 Blakes Room 7.30pm-9.30pm

July 6th, 2026 Blakes Rooms 7.30pm-9.30pm

Robin Hood - the panto

Thurs 26th - Sat 28th Nov

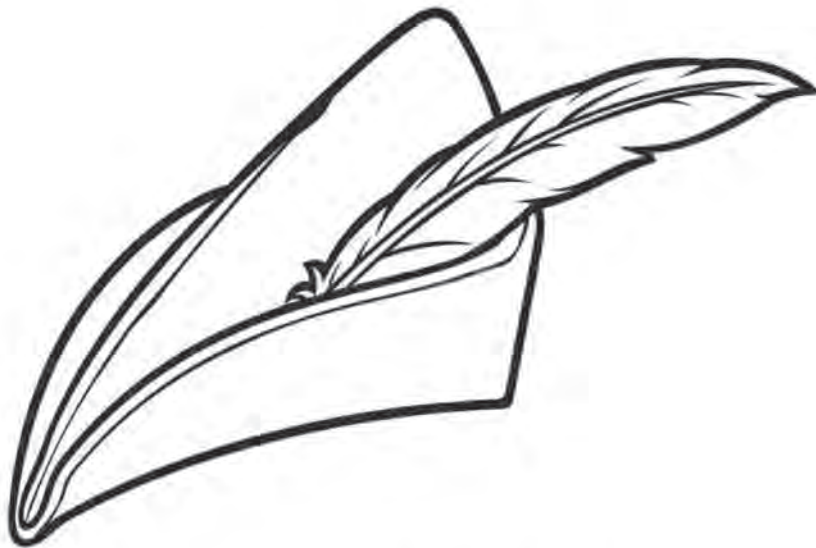

Auditions - Thursday 9th July, 7.30 Soberton Village Hall

If you are interested in getting involved in this hilarious production – either as a cast member or part of the production team, please do come along on the 9th.

There are parts for adults and children, singing and non-singing, as well as opportunities to get involved backstage, on the technical desk or front of house.

Closer to the date we'll be putting more information on the Players website - www.sobertonplayers.co.uk, and social media. If you can't make the audition but would still like to be considered, drop us a mail at sobertonplayers@gmail.com.



I thought I'd just update you all on the latest enrichment opportunities that takes place at Droxford Junior School. These opportunities help to liven, engage and consolidate learning within our school curriculum. They are also designed intentionally to be; challenging and enjoyable.



Each year group has their residential during the year and also our (mixed year 3 / 4 & year 5 / 6) classes go on

school trips to supplement their subject topics. Our Year 5s have just come back from a water sport residential where they learnt to sail (to a RYA level 1 standard); kayaked and used stand up paddleboards.

The Year 4s went to Runways End activity centre for 3 days where they learnt to climb up an 8m climbing wall then abseiled back down; went caving; took part in archery, orienteering, low ropes, shooting and bushcraft.



At the start of the year our Year 6s attend Calshot activity centre in the New Forest. Here they learn to ski; cycle on the velodrome; take part in geography exercises and many other activities. And at the end of the school year our Year 3s have their own camping expedition on the school field.

Throughout their time at Droxford children take part in many trips including Butser Ancient Farm; Southampton art museum; Watercress Line; D-Day Museum; study the River Meon; walk up to Old Winchester Hill; visit the Historic Dockyard in Portsmouth to name but a few.

Our children also take part in many clubs and competitions during and after school. These including sports, music, drama, dance allotment and STEM (Science, Technology, Engineering and Maths).

Finally, we have had many visiting authors, poets, artists, musicians and Theatre companies attend our school. All of which help to engage, motivate and inspire our children!

Matthew Dampier
Headteacher



Bishop's Waltham Photographic Society

Junior & Youth Photographic Competitions



For ages up to 11 years and 12-16 years



WIN AMAZON VOUCHERS! ★★

How to Enter



Email 1 Photo to, competition@bishops-waltham-photosociety.co.uk by midnight on Sunday 23rd August 2026. The email should contain your name & age, title of the image and the contact details of a parent/guardian.



Direct link with QR code.



Children's Week 2026

Monday 27th July to Thursday 30th July



Ahoy Ship Mates, we're looking for 50 of you to sign up for Children's Week!

Applications open on 18th May 2026

To make an application, please complete the form at <https://forms.gle/QvNDQbnFCf2UR6ey8> or email SNCWeek@gmail.com for an electronic link.

Applications close on 7th June 2026

Note to parents – due to works at the Rec, and fewer adult volunteers than previous years, we're restricted to 50 children attending in 2026. Please apply early to avoid disappointment.

Earlybirds Needs Your Tesco Blue Token Vote!



Earlybirds (your local Newtown and Soberton charity Preschool) is very excited to share that our application to the Tesco Grants Programme has been successful, and our breakfast club project will be put forward to a customer vote in Tesco stores (via the blue token charity boxes).

Voting will commence in store from Tuesday 28th April 2026 until the end of July 2026 in the following stores:

- Portchester Express: PO16 9UZ
- Fareham Superstore: PO16 0LE

The project with the highest number of votes across our region will receive £1500, second place £1000 and third place £500. To vote, you will need to make a purchase within store of any value. You will receive one token per transaction, and it's not necessary to purchase a carrier bag in order to receive a token.

Help us to provide a healthy breakfast and enriching activities to our youngest learners, helping them to grow, explore, and thrive – we would be so incredibly grateful for your support.

For more information, please contact the Earlybirds Team: earlybirds16@hotmail.co.uk / 07701259985



Volunteers clock up 550 hours of work for nature

Anyone who has taken a walk on Soberton Down this Spring will have enjoyed a fabulous display of cowslips, with the calls of many different species of bird as a backing track. Add the free “Merlin” app to your smartphone and see how many you can identify?

Nature at its best – but it doesn’t happen by accident. It is only thanks to the 550 hours of voluntary labour on the 10 acre site from September 2025 to April 2026 that the Down is preserved in something like its natural state for us all to enjoy.

SoberNewts have been hard at work most Tuesday mornings over the winter clearing scrub, digging up invasive species and – with the help of a small team of Dexter cattle – clearing the terrain for a beautiful display of chalk downland plants which, in turn, attract a profusion of insects, birds and animals.

And our hard work is paying off: A Habitat Survey recently published by the Hampshire Biodiversity Information Centre concluded that:

“The site represents a valuable area of downland habitat.”

We also found time over the past winter to assist with some tree planting and management for the Hampshire and Isle of Wight Wildlife Trust on St Clair’s water meadow and with the National Trust at Hinton Ampner.

Clearing and preparing verges on the High Street and West Street for wild flower planting is another part of the autumn schedule and we will be clearing nettles soon to let our planting thrive.

In the summer months we turn our attention to maintenance of the village pond which includes a survey of the invertebrates population and the removal of invasive weed. We will also be surveying the native orchids on the Down, possibly counting bumble bees and harvest mice and may also find time to organise some moth counts and nature walks.

To find out what’s on the agenda check our postings on [facebook.com/sobernewts](https://www.facebook.com/sobernewts) which include updates about our activities and fabulous photos and detailed reports as well as news of events you can come and enjoy.

Children’s Sunday Club

Second Sunday of each month 11am – 12 noon

Please join us for fun, learning and friendship.

All children welcome, any age!

In Memory of John Rowlinson

Penny Rowlinson, Tamsin, Kirsty, Rachel and all the Family wish to send heartfelt thanks to everyone who sent such lovely cards, letters and flowers after John's sad death. The wonderful messages mean such a lot to us.

Thank you.

John was treasurer of the Soberton and Newtown Parish Magazine for many years and the magazine team sends our love and kind thoughts to the Rowlinson family.

Money For Youth

The Magazine Committee would like to encourage young people in the two parishes to apply for funds to make possible educational, character-building or adventurous activities. We feel that possibly some young people may not realise that we would be happy to consider applications for quite small sums. It is envisaged, for example, that sums could be used on projects for which the local schools are recommending the applicant. In such cases we would naturally not require extensive articles for inclusion in the Magazine, although we would be very pleased to receive a piece for publication.

To apply for a grant, you should satisfy the following conditions:

- Be aged 25 or less
- Be normally resident in Newtown or Soberton parish
- Be accepted by an officially recognised body for an educational, adventurous, or character-building activity (An official letter should accompany your application)
- Show a requirement to raise a sum of money that could not easily be found

A sub-committee consisting of the Magazine Chairman, Treasurer and one other member of the committee, will consider all applications. The details of the application will be treated as confidential.

The Magazine Committee can make no undertaking that the money will be available for all applicants fulfilling these conditions.

The sub-committee's decision is final.

Please e-mail copy for the August / September magazine to

gill.highcroft@btinternet.com

NEXT COPY DATE - 20th July 2026 (17:00)

The Guide Hut - Annual Report 2026



Huge thanks to the committee for their continued dedication and commitment to the running of the Guide Hut. We welcomed a new member – many thanks to Naomi Ambrose for volunteering to join the team. We've hosted some lovely fundraising events this year including an afternoon tea supported by some local craft stalls and two very successful Christmas Wreath Making Workshops.

This year we finally updated our heating system (with thanks to Danco Ltd), after many years of fundraising, spear-headed by the redoubtable Caroline Rogers. The new heating system seems to be working well and the ability to control the heating remotely through the Dimplex app has proved to be very useful.

Barn Church have become regular users of the Hut on Sunday mornings. It's great to see the Guide Hut being used regularly for a community event. The Bluebirds are also weekly users, using the hut for rehearsals. The Guide Hut has also been used as a venue this year for children's parties and even a baby shower – bringing in much needed income. The Hut continues to be used for Brownies and Guides and as the main venue for Children's Week.

We look forward to another great year for the Guide Hut. If you'd like to find out more about hiring the Guide Hut for an event, please email us on guidehutsoberton@gmail.com.

Caroline Barfoot

Chair of the Guide Hut Committee

Brownies Annual Report – April 2026

Looking back over the past year of Brownie adventures, it's hard not to be amazed by just how much fun and learning we manage to fit in. The girls have been busy, enthusiastic, and full of energy, and it has been a real pleasure to share so many memorable experiences with them.



A Summer of Adventures

The summer term of 2025 began close to home with a fascinating visit to St Peter's Church, where the girls explored the graveyard and climbed the church tower, even trying their hand at bell ringing. We joined Guides and Scouts from across the area for *Scout the Zoo* at Marwell, and a group of Brownies and Leaders travelled further afield for a very special *Night with the Tigers* at Dartmoor Zoo.

Back at the hut, creativity (and chocolate!) took centre stage when The Crafty Chocolatier helped us make our own chocolate pizzas. We finished the term in high spirits with a human version of Hungry Hippos and great fun on bouncy shoes.

The Brownies were proud to support village events, running the candy floss and 'shove a penny' stalls at Newtown Fête. At Soberton Fête, we provided the ever-popular bag creche, and the glorious weather meant the stocks were thoroughly enjoyed by all!

Circus Skills and Community Spirit

Autumn 2025 arrived with circus excitement, as Rainbows, Brownies and Guides from across the Division came together for a day of circus skills, laughter and ice cream. The Brownies also helped at the Hut coffee afternoon fundraiser.

We welcomed Mrs G to teach us Pilates (with impressive flexibility!) and were honoured to parade the standard at the Remembrance Service at Droxford Church. The term ended on a festive note with a Girlguiding cinema screening of *Zootropolis 2* and some delicious Christmas biscuit baking.

Dancing into Spring

The spring term focused on leadership skills – although it involved plenty of dancing, acting and dressing up! The real aim may have been to teach the girls the Macarena, *Saturday Night* and other disco classics. To celebrate 100 years of World Thinking Day, we watched the Guides perform a play written by Victoria Rogers and finished with a Division silent disco.

Looking Ahead

For the coming summer term, we are looking forward to another *Scout the Zoo* visit and a campfire at Meonwood.

Our Leadership Team

During the autumn term, the pack saw a change in leadership. Caroline Rogers stepped back, and Grace Parker (Ladybird) and I took on the role of Brown Owl. We have been wonderfully supported by Victoria (Mole) over the past two terms, although she is currently away for the summer on an archaeological dig in Lincolnshire. Our thanks also go to Paula Hobbs (Snowy Owl) and Katie Povey (Penguin), along with Abi Davis as Young Leader and Rose Cleeve as Brownie Helper. Their support is invaluable. We are always grateful for help from the village community, so if you would like to assist at a meeting or two, or even for a term, we would love to hear from you.

Joining Brownies

If your daughter is aged between 7 and 10 and would like to join Brownies, please register your interest at www.girlguiding.org.uk.

Mandy Haggar

Brown Owl, 1st Soberton & Newtown Brownie Pack

✉ sobertonnewtownbrownies@gmail.com

Guide's Recap



So what have we done in the past 12 months ...

Last summer (2025) we rang the church bells at St Peter's, visited Marwell Zoo, had a Tennis session at Swanmore tennis club, cooked, played human hungry hippos and Bounced with Donna with the Brownies.

The new School term in the autumn started with 6 new Guides from Brownies and a Division Circus day. We also did a Bird & Blend challenge badge in a day, made giant poppies for the RBL service, watched Zootopia 2 at Port Solent with 1000 other guiding members and finished for Christmas with a roller skating session.

The start of 2026 has been just as busy, with a Campfire, celebrating 100 years of Guiding's Thinking day as a Division with a silent disco, completing our Codebreaking badge, Our stage 3 First Aid badge, working on our Guiding History badge and attending the Portsmouth Cityscape adventure (a Citywide Scavenger Hunt) with 2700 other guiding member's just before Easter.

All this and we only meet on alternate Mondays!!

Our numbers have fallen slightly this term to 13, due to our older Guides moving on.

We have also lost one of our leaders, Victoria Rogers, this term, as she starts a new Archaeology project in Lincolnshire, but she will be still helping with our admin. She will be missed, not just by the Leaders but also the Girls.

My thanks go to the other Guide leaders: Helen Dyne, Paula Hobbs, Katie Povey and Victoria Rogers, as they continue to support my wacky ideas, and enable the Guides to try out many new adventures.

We have lots planned for Summer 2026 and beyond, so watch this space.

Caroline Rogers

Soberton & Newtown Guide Leader

Guides are aged 10 -14 and we meet on alternate Mondays during term time. If your daughter is interested in joining us please contact SobertonNewtownGuides@gmail.com

Soberton & Newtown Ladies Group

In April Mandy Hagger gave an entertaining and informative talk about the various pests she has come across and action required to irradiate them. We had a successful Progressive Supper in May. Thanks are due to the hosts and those who contributed desserts.

Our AGM is on 3rd June, where we consider ideas for next year's programme. The meeting will take place in Rosemary Taylor's Garden Room, Rivendell, Webbs Green, Soberton.

On 1st July we have a garden visit to The Thatched Cottage, Upper Farringdon. This is open to partners or a guest.

Helen Stranks 01489 878270 helen.stranks@btopenworld.com
Liz Whales (Secretary) 01489 877712 lizwhales@aol.com

Look on the Bright Side

Segalula Women in Song

Come and join us for a summer selection of a cappella favourites

Saturday 4th July 2026

7pm - 9pm

Shedfield Study Centre
(behind St. John's Church)
Church Road, Shedfield SO32 2HY

A collection will be made on behalf of

Entry £7
on the door
(to include a glass of wine or soft drink)

Meon Valley Home-Start

Ticket Enquiries -
Email: segalula22@gmail.com

Rookesbury Hall – dates for your diary!

Saturday 7th November - murder mystery supper evening
Saturday 28th November - Makers Market

Soberton club players win the Portsmouth Stannard Shield



In the 3 person teams for the **Portsmouth Constad Cup handicap event**, Soberton A had a nail-bitingly close game in the Final, but ultimately lost 5-4 to Emsworth Eagles. Well played Richard Billings, Chris Langdale and Pete Woodacre.

Amazingly in the 2 person teams for the **Portsmouth Stannard Shield handicap, for players over 40**, Soberton A played Emsworth Eagles again, but this time won 5-3 thanks to Chris Langdale and Pete Woodacre.

As we conclude the winter league, which runs October to March, the **'A' team in Portsmouth League Div 1** finished in 5th place hit by injuries. Top performers were Andy Prince 88% on 3 matches, David Woodacre 66% but he still retained League player of the match award, and Richard Billings 46%.

The Soberton & Newtown **'B' team in Portsmouth Div 2** finished 6th competing in a stronger division. Top performers were Robin Plunkett 75% , Bill Moody 66% and Chris Langdale 45%.

In **Portsmouth Div 4** the Soberton & Newtown **'C' team** came 5th with Henry Laferla on 70%, Roger Wingrove 63% and Jeff Crate 57%. We also had a brand new team Soberton & Newtown **'D' team** who finished 8th in their first season with Simon Gomer on a commendable 45%.

In the **Gosport & Fareham League** the **'A' team** were missing some key players due to injury, and the previous B team took their place playing in Div 1 which proved a very tough season.

We have 2 teams in the **South East Hants Summer League 2026** which runs from April to July and will advise on progress in future magazines. The A team won the 2025 SE Hants Summer League.

The Soberton & Newtown Table Tennis Club that plays at Soberton Village Hall will close for August and re-open in September. If you would like further information, please get in touch with either:

Pete Woodacre (petewoodacre@gmail.com ; 01489 877768) or Adrian Hunt (adrianhunt8@gmail.com ; 01489 878141).

STUDIO 6 DESIGN & PRINT

Business Cards & Letterheads • Leaflets & Flyers
Wedding Stationery • Funeral Orders of Service
Banners & Signage • Booklets & Brochures
Personal Stationery • Labels, Rubber Stamps & much more!

www.studio-6.co.uk

We have new premises!

PLEASE CONTACT US VIA PHONE OR E-MAIL

01329 832933 • print@studio-6.co.uk

EXPERT TAX ADVICE WITH A HUMAN FACE FOR THE MEON VALLEY

WATCHING OUT FOR THE NEXT GENERATION

Is IHT a factor in making my Will? Is a Family Trust a good idea?

PROPERTY OR WORK OVERSEAS

How does it affect my tax if I live, work or have property abroad?

FOR ENTREPRENEURS

Am I the only one wondering whether it's worth all the aggro?

PERSONAL TAX

What is the best way to order my tax affairs, in full compliance with the law?

SELLING MY BUSINESS

How much tax will I pay? What is my business worth?

Nicholas Ridge ^{Est}
TAX EXPERTISE

Oakleaf, Ludwells Lane, Waltham Chase, Southampton, SO32 2NP

t: 01489 899102 e: nicholas@nicholasridgecta.co.uk

www.nicholasridgecta.co.uk

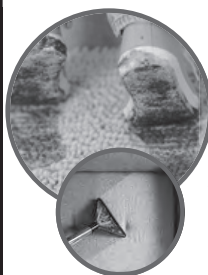

Elliott
CARPET CARE

Est. 2003

Enjoy professional cleaning that restores your carpets, making them look fresh again.

Local Family Run Business

☎ 07436 266078

🌐 www.elliottcarpetcare.co.uk

✉ elliottcarpetcare@gmail.com

Carpet Cleaning

Upholstery and Leather

Curtains and Suites



All aspects of Carpentry & Building work undertaken

- Extensions • Alterations • Refurbishments
- New Builds • Landscaping

Tel: 02392 632037 Mob: 07885 283036

jay.tucker16@yahoo.co.uk

Fully qualified and insured



The Perfect Space for Meetings or Committees

HOST YOUR NEXT MEETING OR
PRESENTATION IN A DISCREET AND
PRIVATE AREA.

RURAL LOCATION NEAR HAMBLEDON.

- Seating area for 6 to 8 people.
- Parking up to 4 cars.
- Ultra Fast Internet.
- Coffee, tea, cold drinks facility.
- WC.

ENQUIRIES:

Contact Ben **07973668539**
by text or WhatsApp

Discount offered for repeat or regular bookings.

FOR ALL YOUR DRY CLEANING AND LAUNDRY NEEDS

Duvets Laundered
Curtain Cleaning & Alterations
Tailor Repairs & Alterations
Wedding Dresses Cleaned & Boxed
Specialist Rug Cleaning Service



Laundry Service
Carpet Cleaning Machine Hire
Waxed Garments Cleaned & Re-Waxed
Pillows Cleaned & Recovered
Suede & Leather Cleaning

4 Merlin Mews, Bishop's Waltham. Tel: 01489 894421 • Agent: Meonstoke Post Office

www.bryantscleaners.co.uk

MARK & JUNE MASON

Husband and wife high quality painters and decorators. Period to modern properties, one room to a whole building. We work around your requirements.

www.masonspaint.co.uk

Phone 01329 235847

Mobile 07973 162397



SAFER CHIMNEYS

Member of National Association of Chimney Sweeps
NACS Certificates Issued.

“Highly Recommended” Local Chimney Sweep

Power Sweeping, Traditional Brushes,
Chimney Camera Surveys
Stoves, Open fires, Range Cookers
Less waiting time – 2 qualified sweeps

023 9247 6458 or 07733 343530 or 07847 466281

Proud members of
Checkatrade.com
Where reputation matters

www.saferchimneys.co.uk

WELLER PATRICK

SOBERTON AND MEON VALLEY PROPERTY EXPERTS

**Experienced local team with
detailed knowledge of the area.**

01489 893555

**www.wellerpatrick.com
info@wellerpatrick.co.uk**



If you're considering selling or renting your property, contact us for a free, no-obligation market appraisal.

ESTATE & LETTING AGENTS

The Square, Wickham, Hampshire PO17 5JT · Telephone: 01329 834579

Email: info@byrneandco.uk · www.byrneandco.uk



THE WHITE LION

BED & BREAKFAST

**BEER GARDEN,
FUNCTIONS, HOME
COOKING AND
LOCAL BEERS**

TELEPHONE: 01489 877346

INFO@THEWHITELIONSOBERTON.CO.UK
WWW.THEWHITELIONSOBERTON.COM

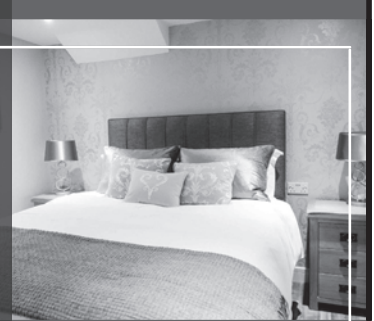

Pressing Needs



The Fabric Care Specialists

FREE

Collection & Delivery
Tuesday & Friday

25% off Duvet Cleaning
with Promo Code: S&N25

www.pressingneeds.co.uk
verity@pressingneeds.co.uk

- Laundry
- Dry Cleaning
- Ironing
- Shirt Service
- Bedding Laundry
- Duvet Laundry
- Curtain Cleaning

Duncan Rd, Park Gate, Southampton, SO31 1BD

01489 582095



MARK OLIVER
Plumbing & Heating



All Domestic Plumbing Undertaken

Fully Insured & Qualified
Covering Your Area

Oil Boiler Heating Specialist

Oil Boiler Installation and Servicing

Approved Grant Boiler Installer

12 Month Guarantee on all Installations

BLUE LIGHT CARD & SENIOR CITIZEN DISCOUNT AVAILABLE

Contact: 07476 924619 / 01489 876556

24 hrs: 07743 386540



email: moliverplumbing34@gmail.com

www.moliverplumbing.co.uk



Mushroom Catering

**Bringing Masterchef
to the Meon Valley**

Masterchef contestant Gill Holland provides bespoke menus that give your special occasion the wow factor! Traditional British fare, a Thai feast or a Mediterranean mezze, canapés at a drinks party to full wedding packages.

Whatever your event give Gill a call on the contact details below:

www.mushroom-club.co.uk
West Down Cottage, Chalk Hill,
Soberton, SO32 3PH
07879 696495, 01489 876741

MEON VALLEY
Mowers
SERVICE AND REPAIRS

Specialist in professional & domestic
mower & garden machinery

- Service & repairs
- Collection & delivery
- Competitive rates
- Rotary blades, cylinders & hedge cutter sharpening
- Visit our workshop



07783 937212 or 01489 878085
info@meonvalleymowers.co.uk



MJM

Plumbing & Heating

36 years experience in the plumbing & heating industry

- Natural gas, L.P.G and oil boilers installed
- Oil tanks installed & maintained
- Power flushing
- Full bathroom installations including wall & floor tiling
- Unvented hot water systems installed, serviced and maintained
- Grant Oil Boiler Approved Installer

NO
CALL OUT
CHARGE

**NOW OFFERING 0% finance on all
Vaillant boilers and products!** Call for details

Tel: **01329 507712** Mob: **07773 385946**
info@mjmplumbing.co.uk www.mjmplumbing.co.uk



Based in Wickham

TJ

CHIMNEY SWEEPS

TEL: 02392 002872

MOB: 07950 145494

COMPETENT, CLEAN & RELIABLE

WWW.TJCHIMNEYSWEEPS.CO.UK

FULLY INSURED & REGISTERED WITH THE INSTITUTE OF
CHIMNEY SWEEPS.

SEE US ON CHECKATRADE.COM

To advertise please contact:

Kate Buttriss

kate.buttriss@gmail.com

07801 441998

All seasons general garden maintenance

Mob: 07763 494006 Tel: 01489 878 598

tudorgardener@gmail.com

@Tudorgardener

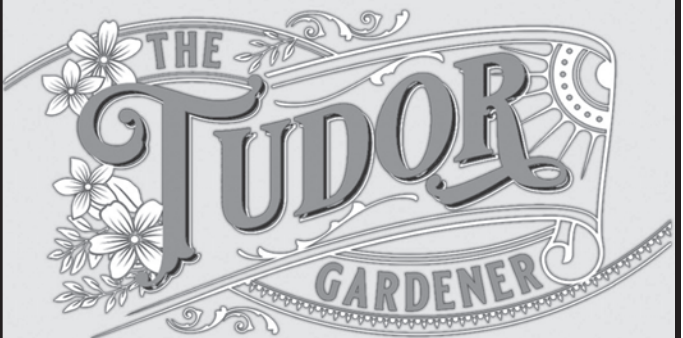

Specialising in:

- Hedge cutting & shrub shaping
- Garden design
- Fruit tree and rose pruning

RHS TRAINED

SYCAMORE TREE SURGEONS

All aspects of tree work

**Pruning Surgery Felling Hedgecutting
Tree Stump Removal and Site Clearance
Approved contractors for local authorities**

FULLY INSURED

023 9223 0146

Mob: 07889 704449 David Farrington

30 YEARS EXPERIENCE



J. Gordon

Forestry & Arboriculture Ltd

- Crown Reduction/Re-shaping • Thinning/Dead Wooding • Skilled Tree Removal • Hedges
- Plantation Maintenance • Tree Planting • Fencing • Woodland Management • Stump Grinding

Professional Qualifications • Insured in all aspects of forestry and tree surgery

For a personal and caring service contact Joe Gordon

24 HOUR EMERGENCY CALL-OUT • FREE QUOTATIONS

Hambledon 023 9263 2418 Mobile 07712 808 081 www.treedocjoe.co.uk



Taylor's Garage
Droxford
Hampshire SO32 3QL



Tel: 01489 877433

CAR and MOTORCYCLE MOTs

**Service and repair to cars
light commercials and horse trailers**

Air conditioning - service & repair

**Competitive prices on
tyres batteries and exhausts**

**Collection & delivery or loan car available
subject to availability**

BUY WITH CONFIDENCE
Trading Standards Approved Trader



PILATES

PILATES



Kate Broom Dip MCFHP MAFHP

Heels 2 Toes

Foot Health Practitioner

Caring and friendly foot care and maintenance



Located upstairs in
Birchall and Haydock Pharmacy,
The Square,
Wickham,
PO17 5JQ



07747 436359
Heels2toesuk@outlook.com

DBS checked and Insured

Member of the Southern Chiropody and Foot Health Practitioners Association and The British Association of Foot Health Professionals



SOLENT DESIGN

- Design
- Artwork
- Stationery
- Leaflets
- Flyers
- Brochures
- Booklets
- Newsletters
- Labels
- Postcards
- Folders
- Posters
- Banners
- Vinyl
- Exhibition Displays



Tel: 01489 892344 • Email: sales@solentdesignstudio.com
www.solentdesignstudio.com



ANDREW
SMYTH

Your local

HANDYMAN

DECORATING SERVICES

General Home Maintenance

Painting & Decorating

Carpentry & Fencing

Plumbing & Electrical

Domestic & Commercial

AND MUCH MORE...

07909 253681

andrew.j.smyth65@gmail.com



AndrewSmythHandyman

Wickham Fisheries

Your local Take Away

A wide variety of food

Gluten-free chips available everyday

Gluten free menu for other products
available every day (call and place your
order half an hour before collection)

Find all opening information and our menu
on Facebook – Wickham Fisheries

The Square

Wickham

PO17 5JQ

Tel 01329 832394



Local & Award Winning Luxury Self-Catering

- Ideal for family gatherings, celebrate here!
- Indoor heated pool and jacuzzi with hoist, sauna & steam room
- Hot tubs, en-suite bedrooms, wood burners
- Dog friendly, enclosed gardens, accessible
- Country views, EV charging points, free WiFi

WALLOPS WOOD COTTAGES

wallopswoodcottages.co.uk

GRENVILLE AT WALLOPS WOOD

grenvilleatwallopswood.co.uk

01489 878888

unwind@wallopswoodcottages.co.uk

Book with confidence and unwind with us

RICHARD STEEL & PARTNERS

THE FAMILY OWNED
FUNERAL DIRECTORS



Incorporating
Nigel Chamberlain
& Partners for
over 30 years

www.steelsfuneral.co.uk

BISHOP'S WALTHAM

The Gate House, Victoria Road,
Bishop's Waltham, SO32 1DJ
01489 892640

WINCHESTER

Alderman House, 12-14 City Road,
Winchester, SO23 8SD
01962 862333

Available 24 Hours

B.G. Property Maintenance

EST 1974

Internal and External Painting &
Decorating

Roof Repairs – Gutter Maintenance

Pointing – Brickwork & Plastering
Repairs

Glazing – Tiling – Paving – Carpentry

CLINT: 07836 620844

BOB: 07971 551513

Email: rgoble717@btinternet.com

FULLY INSURED
FREE QUOTES

BOWMAN

ALES LTD.

TRY OUR AWARD WINNING ALES



Our beers are
available in
bottles,
bags-in-boxes or
casks, all direct
from the brewery



01489 878 110

info@bowman-ales.com www.bowman-ales.com



Household and Business storage

02392 384 888

BARN-STORE.CO.UK

Offwell Farm, Southwick, Fareham, PO17 6DX



The Boat Bosun provides high quality,
shipwright, marine engineering, painting, and
coating service to traditional and modern boat
owners of wooden and GRP,
yachts and powerboats.

david@theboatbosun.com

07971 288064

theboatbosun.com

KS Groundworks

Local General Builders & Ground Maintenance, Hardscaping, Drives, Slabs, etc.

Over 30 years experience.

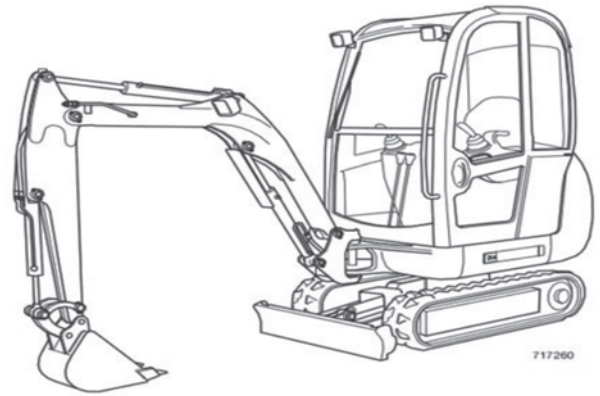

Tel: 07801 141517 Email: kym.slater@gmail.com

LOCAL FARRIER

(Soberton Based)

David Povey Dip WCF

For:

Hot & Cold Shoeing
Remedial Shoeing



Established 1985

01489 878218

Hurricane Farm



Our Services:

- Mobile educational farm
- Incubator hire
- Breeders of pedigree Tamworth and Gloucestershire old spots
- Breeder of rare breed poultry and garden hens
- Supplier of quality pork

01489 878218 - 07876244146

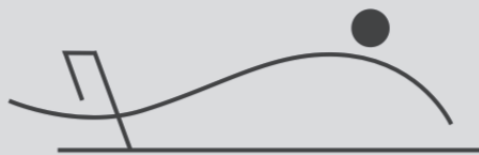

PILATES

H A M P S H I R E



YOUR FUTURE SELF IS WATCHING!

Improve the way you move every day

Enhance flexibility & mobility

Improve Spinal Alignment

Correct Posture

Strengthen the Deep Core

Beginners Welcome

**A PRIVATE (1:1) CLASSICAL PILATES
STUDIO
OFFERING TAILORED SESSIONS**

Fully equipped studio

Becky: 07891221630 **BGiulieri@gmail.com**

www.pilateshampshire.co.uk

CHAMBERLAINS

Family Solicitors

We can help you with a wide range of legal services including Residential Conveyancing, Commercial Property, Probate, Wills and Lasting Powers of Attorney

RED LION STREET (OFF HIGH STREET), BISHOPS WALTHAM
TEL: 01489 896141
info@chamberlainslaw.co.uk

StorAway

Your local choice for storage



Secure Storage for Classic Cars, Archived Documents and Personal Property. Long or short term storage options available.

For ALL your storage needs
Contact StorAway on 01489 877988
or www.storaway.co.uk

LBH LANDSCAPE & GROUND WORKS Ltd

Free Estimates - Quality Work - Competitive Prices

**Brick Laying • Block Paving • Patios
Concreting • Drainage • Extensions
Garages • Decking • Fencing • Turfing**

All other aspects of Hard and Soft Landscaping and Maintenance

KEVIN HALL 07808 496004
Tel: 01329 832169 Email: lbhkevinhall@gmail.com



G. RIXON LTD.

ELECTRICAL PLUMBING AND HEATING ENGINEERS



01329 834600

enquiries@g-rixon-ltd.co.uk

www.g-rixon-ltd.co.uk

We carry out small jobs such as attending to faulty light fittings and dripping taps, to larger jobs such as complete rewire and replacement bathrooms. We are disabled adaptation specialists and install level access showers and accessible kitchens.

G. RIXON LTD. Wynot Heath Road Soberton Hampshire SO32 3PQ



APARTMENTS FOR HIRE



Luxury One bedroom

We are offering this luxury apartments in Gosport. Fully furnished and equipped. High speed Internet.

ALL BILLS ARE INCLUDED

NO DEPOSIT, NO FIXED CONTRACT, NO MINIMUM OR MAXIMUM STAY.

IDEAL FOR:

Accommodation for business contracts.
Insurance placement.
Long term guests.
While house works are on going on.
Change of personal circumstances.
In between house moves.



For more information of pricing

CONTACT: Ben 07973668539

R & G GAMBLIN

Extension Alteration Renovation

Planning work

Bricklaying.
Civil Engineering.
UPVC Windows & Doors.
Plastic Fascia & Soffit.
Concrete.
Loft Conversion.
Roofing Pitch & Flat.
Painting.
Conservatories.

Digger Hire.
Drainage.
Fencing.
Plastering.
Driveways.
Plumbing.
Garages.
Carpentry.
Electrics.

For Free Estimates please phone
Rob 01489 - 891801



LOGS



Locally sourced, barn stored, seasoned hardwood logs

Delivered locally for free in bulk bags or loose loads.

Charges may apply for long distance deliveries

For enquiries contact Charlie

Email: hambledonlogs@gmail.com

Tel: 07788907334

TREE SERVICES

RESIDENTIAL & COMMERCIAL
HAMPSHIRE & SURROUNDING AREA

FOR MORE INFORMATION
www.wgstreeservices.co.uk

info@wgstreeservices.co.uk
or
CALL 07810 044 420



BULK BAGS

HARDWOOD | SOFTWOOD | KINDLING
FREE LOCAL DELIVERY

CALL 07810 044420
or

ORDER SECURELY ONLINE
www.wgskindling.co.uk

FOLLOW US

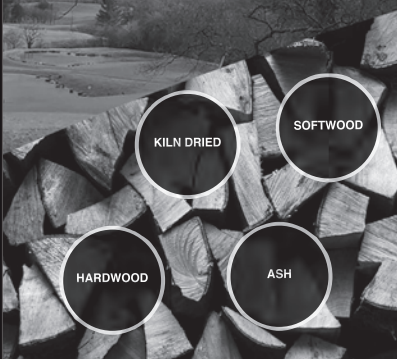

ICAEW
CHARTERED
ACCOUNTANTS

*Chartered Accountants
& Registered Auditors*

LOCAL INDEPENDENT ACCOUNTANTS AND
TAXATION ADVISORS

FREE INITIAL CONSULTATION

Full range of accountancy, auditing and taxation services

Business start up advice

Book-keeping and Payroll Services

Self-Assessment Returns

Detailed Fixed Cost Quotes

Visits to your Premises

Avalon House, Waltham Business Park,
Brickyard Road, Swanmore, Southampton,
SO32 2SA

Tel: 01489 896996 Fax: 01489 895255
Email: enquiries@butlerco-bw.co.uk
Website: www.butlerco-bw.co.uk

Strength,
flexibility
and
balance



BIRCH TREE
YOGA

Offering a range of
classes for all levels in a
woodland setting

birchtreeyoga.co.uk
07776238904



Tudor

PEST CONTROL

Mandy Haggart BSc.
07307 167 244

info@tudorpestcontrol.co.uk
www.tudorpestcontrol.co.uk

ECS
Easy Clean Services

Contact Us Now!
Tel: 01489 896 903

CESSPIT / SEPTIC TANK EMPTYING

TANK EMPTYING

- Cesspits
- Septic Tanks
- Interceptors
- Grease Traps
- Treatment plants
- Pump Stations



SERVICING

- All Treatment Plants
- Pump Sets
- Pumping Stations
- Water Pumps

PUMP and PARTS

- Air Blowers - All Makes
- Submersible pumps
- Spares and accessories
- Shop online or collect

DRAINAGE SERVICES

- Root Cutting
- CCTV Surveys
- Blocked Drains (Jetting/Rodding)

info@easycleanservices.co.uk
www.easycleanservices.co.uk

D.J. SCOTT
GARDEN MACHINERY

SALES & REPAIRS

Wheely Down Garages
Warnford, Nr. Southampton
Hampshire SO32 3LG

Telephone/Fax: 01730 829207
www.dj-scott.com

WINDOWS CLEANED TODAY

DM
EXTERIOR CLEANING
SERVICES

TRY OUR OTHER SERVICES

- Windows
- Gutters
- Fascia's & soffits
- Conservatories
- Roofs & Render
- Paving
- Bird proofing (chimneys & solar panels)

07815 698 140

bacs

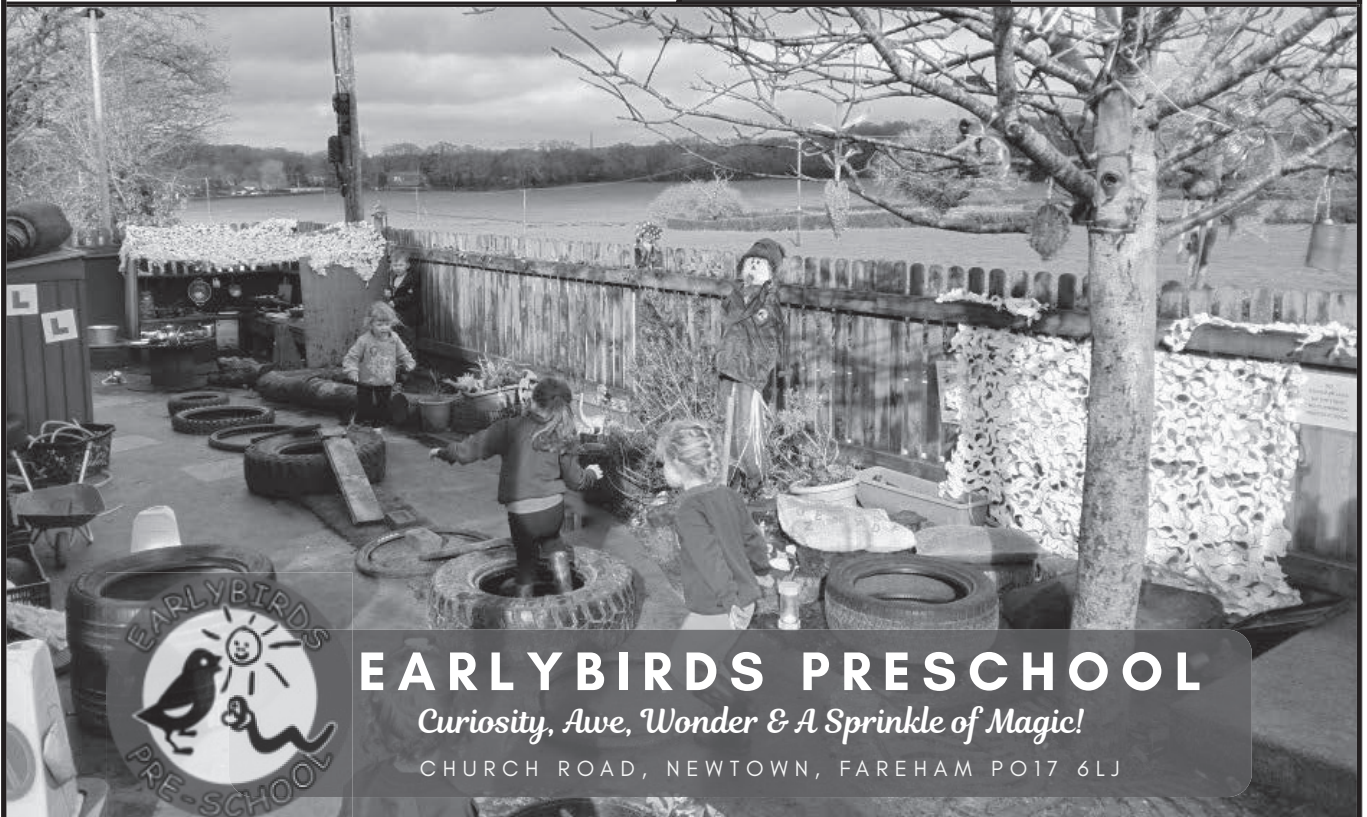

EARLYBIRDS PRESCHOOL

Curiosity, Ave, Wonder & A Sprinkle of Magic!

CHURCH ROAD, NEWTOWN, FAREHAM PO17 6LJ

- Open during term time for 2-4 year olds.
- Full wraparound care available.
- Great link with Newtown Soberton Infant School.
- Funding accepted.

www.earlybirdspreschool.co.uk

earlybirds16@hotmail.co.uk

07701259985

Ofsted
Good Provider

DROXFORD ANTIQUES

The Old Bakery, High Street, Droxford SO32 3PA

01489 878800 07973 551519 07815 562424 mark@droxfordantiques.co.uk

Established for over 40 years.

Still buying and selling antiques of all descriptions, valuations and probate service.

We repair, restore and polish in our own workshops.

CURTAIN MAKING, ALTERATIONS & UPHOLSTERY

Stockists of Kate Forman, Vanessa Arbuthnott, Ada & Ina

We offer a full service from measuring to making beautiful hand sewn curtains, blinds and pelmets especially for you.

Please telephone Mark or Mary for free, professional and confidential help and advice.



THE JOINERS SHOP

Period Joinery of Every Description

Conservation Approved
Double Glazed
Box Sash Windows

(Genuine) Handmade Kitchens

Tel: 02392 814780
enquiries@thejoinershop.co.uk
www.thejoinershop.co.uk



Associate Member of the Hampshire
Buildings Preservation Trust Ltd

Associated Trades



DOMESTIC
INSTRUCTORS



M & S LOCKE & SON LTD

PLASTERING & CERAMIC TILING CONTRACTORS

Specialising in:

- All aspects of plastering
- All aspects of tiling
(inc. porcelain & stone interior/exterior)
- Full bathroom refurbishments

Family run business with over 30 years experience,
we offer a reliable, friendly, and quality service.

**For a free quotation/advice please call Dean on
Mobile: 07712 894119/Home: 01489 877199**



HAMBLEDON GARDEN MACHINERY

All aspects of garden machinery
repairs and servicing, including
small plant & agricultural tractors
Delivery and collection available

Get in touch

☎ 07788 907334

WHITE ROSE PLUMBING

Russell Beaumont

Free quotation
No call out charge
No job too small
Family run local business
24 hour emergency service

Tel: **01489 893419** Mobile: **07843 586366**
Email: whiteroseplumb@googlemail.com

F A R E H A M Creek V E T S

32 East Street, Fareham PO16 0BY
www.farehamcreekvets.co.uk
Tel: 01329 280412

Local, independent small animal practice
Friendly, dedicated care for you and your pet
See the same vet at each visit
Close to Fareham town centre • Parking on site
24 Hours Emergency Service



CARTERS

GARDEN MACHINERY
SINCE 1921

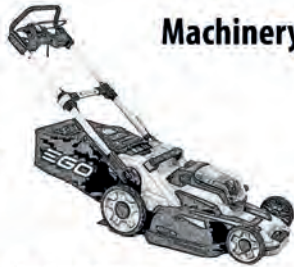

Machinery Sales | Service | Repairs | Hire

Robotic Mower Specialists
Free Site Surveys & Advice
Lawnmowers & Ride-Ons
Hedge & Brush Cutters
Chainsaws & Safety Clothing
Leaf Blowers & Vacuums



SEGWAY

STIHL

Mountfield

WEIBANG

Husqvarna

EGO

STIGA

ALKO

Call us on: **01489 575242**

Visit Our Store or Buy Online

www.cartersgardenmachinery.com



Duncan Road, Swanwick, Southampton, SO31 1BD. (Opposite Swanwick Railway Station. Follow the signs to the station from Park Gate.)



Oliver

CHIMNEY
S W E E P



OliversChimneySweep.co.uk

Brush 'n' Vac, Insured up to 5 million
All types of fires & appliances cleaned
Accredited certificate issued after every sweep

info@oliverschimneysweep.co.uk

0800 0133323

07889 488010



HAMBLEDON
CARS

PRIVATE HIRE SERVICE

Superior Air Conditioned Cars

**Airports, Stations
& Cruise Transfers**

Lisa & Mark:

07766 027 301

Email: hambledon-cars@hotmail.co.uk

VALLEY CARS

PRIVATE HIRE SERVICE

Superior Air Conditioned Minibus

Steve Eames:

07961 652 455

Email: valleycars2025@outlook.com

North ProBuild Ltd.

**General building, Extensions,
Refurbishments, Kitchens,
Bathrooms, Landscaping,
Driveways, Patios, Decking,
Equine Yards and Stables**

**Portfolio & References available,
helpful friendly reliable advice.**

Local Family run business in Soberton.

Please contact Darren

- ◆ darrennorth75@gmail.com
- ◆ 07946 106431
- ◆ 01329 833997



A RIBA CHARTERED PRACTICE



Listed buildings



Bespoke residences



Conversions

"Anthony is a fantastic architect, who is passionate about what he does!"



PASSIONATE ABOUT SUSTAINABLE LIVING

01329 717515 | enquiries@dwell-design.co.uk

Leading the way in providing an **AFFORDABLE PROFESSIONAL** service

WESTMINSTER LAW

Wills ~ Estate Planning ~ Probate



If you are over 60 it will cost you only **£95*** for us to prepare your Will. We are also Lasting Power of Attorney specialists - only **£120*** each LPA if instructed during the Will appointment. *Our prices include VAT, home visits*, and Inheritance Tax advice.*

Call us now for a no obligation chat on
02392 706980

www.westminster-law.co.uk email: info@westminster-law.co.uk

Westminster Law Ltd, Reg. Office: Wellesley House, 204 London Road, Waterlooville PO7 7AN

*These very special rates are only available if you are over 60 years old. Minimum spend for a free home visit is £95. Our normal price for a standard single Will is £160, or £270 for a couple.

Journeys of faith for discerning Christian travellers

£50 off*
any Fellowship
Tour for
all readers!

For over 40 years we've arranged pilgrimages for churches. In the last decade, we've developed our Fellowship Tours – designed for individual travellers who want to deepen their faith, explore places of Christian significance and share the journey with like-minded companions.

On a McCabe Fellowship Tour, you'll enjoy:

- ♥ Journeys to key biblical sites and Christian heritage locations
- ♥ Encounters with local food, art, history and people
- ♥ Daily worship and reflection led by an experienced McCabe leader
- ♥ Fellowship with other like-minded travellers

More than just travel, McCabe Fellowship Tours offer opportunities to grow, reflect and connect in some of the most inspiring places on earth.

*£50 off per person on any new booking for a McCabe Fellowship Tour made by 31st December 2025. Quote code 'PARISH50' when booking. Offer valid for new bookings only, cannot be combined with other discounts and is not transferable or redeemable for cash.

For more information:

🌐 www.mccabe-travel.co.uk
☎ 01252 226133



SDS ROOFING SERVICES LTD

Celebrating

As a Limited company

Lead Work • Tiling • Shingles • Slates • High Performance Torch on Felt Systems
• Green Roofs • Single Ply Membranes • New Builds • Repairs

🌐 www.sdsroofingservices.co.uk ☎ 01489 788 577 ✉ info@sdsroofingservices.co.uk



Computer Problems Solved

A qualified & experienced Computer Engineer who can efficiently solve your home and business computer needs.



For a friendly, no obligation quote call:

Chris Guénier: 01489 890738 or 07962 641796



<http://www.cps-ltd.org.uk>
info@computerproblemsolvedltd.co.uk

Mrs G's Pilates

- Enhanced core strength
- Improved flexibility
- Greater postural control



- Freedom of movement
- Self awareness
- Sense of well being

Tuesday Rooksbury Hall 0915-1015. **Wednesday** Meon Hall 0915-1015, Rooksbury Hall 1830-1930.

Thursday Denmead 0915-1015, Knowle 1100-1200, Rooksbury Hall 1830-1930

Friday Droxford 0915-1015 & 1030-1130

Contact Charlotte :07776221077 or charlotte@mrgspilates.co.uk



GATES
HOUSE
GARDENS

Beautifully built indoor and outdoor living spaces from a local, expert team.

Garden buildings, decking & patios • Driveways, walls & fencing
Design ideas & solutions • Building alterations & extensions
Drainage & groundworks



Jon has 30 years experience and a skilled and reliable team.
Give him a call or WhatsApp for an obligation free chat or quote.

gateshousegardens.com | 07885 663829 | @gateshousegardens

Need Transport to Medical Appointments?



SOBERTON AND NEWTOWN Good Neighbours Group

We are here to drive local people, of all ages, to hospitals, GP surgeries, dentists, opticians and other health practitioners. Our friendly volunteer drivers use their own cars, are all DBS checked and fully insured. *A donation towards fuel costs is requested.*

CAN YOU HELP US?

If you would like to *join* our driving team, we would love to hear from you. All our volunteer drivers decide which journeys they can offer, and are reimbursed for their mileage.

For more information, call:

Kate Harvey on 07843 496 852

Kate Chesters on 07710 716 664



www.soberton-pc.gov.uk

What's on

Month	Date/day	Event / group	Time	Details
June	2 nd	Stitch & Chatter	14:00	See below
	2 nd and 16 th	Soberton Ringers	19:30	Page 2
	3 rd	S&N Ladies Group - AGM	20:00	Page 14
	4 th	Soberton Players - play reading evening	19:30	Page 6
	4 th	Soberton Players - play reading evening	19:30	Page 6
	10 th and 24 th	Pop in for coffee and cake at St Peter's	10:00	Page 4
	11 th	Local History Society - guided walk	-	Page 35
	14 th	Children's Sunday Club	11:00	Page 10
	26 th	Meet&Eat	12:30	See below
July	27 th	Soberton Fete	13:30	Page 5
	1 st	S&N Ladies Group - visit	-	Page 14
	6 th	Soberton Players - play reading evening	19:30	Page 6
	7 th	Stitch & Chatter	14:00	See below
	7 th and 21 st	Soberton Ringers	19:30	Page 2
	8 th and 22 nd	Pop in for coffee and cake at St Peter's	10:00	Page 4
	9 th	Soberton Players - auditions for Robin Hood - the panto	19:30	Page 7
	9 th	Local History Society - Amberley Museum	-	Page 35
	12 th	Children's Sunday Club	11:00	Page 10
	19 th	Meon Valley Garden Club Summer Show	13:30	Page 36
	20 th	COPY DATE FOR AUGUST / SEPTEMBER	17:00	-
	27 th - 30 th	Children's Week 2026	-	Page 9
	31 st	Meet&Eat	12:30	See below
Hold the date				



As we get near summer, some clubs / societies / activities stop until September.

If you are unsure, please check before going.

CONTACT NUMBERS – LOCAL CLUBS AND INTEREST GROUPS

BROWNIES	SobertonNewtownBrownies@gmail.com	
GUIDES	SobertonNewtownGuides@gmail.com	
STITCH & CHATTER	Sandra Henderson	01489 877978
	Liz Whales	01489 877712
LOCAL HISTORY	Lyndon Palmer	07881 991763
SOBERTON PLAYERS	Susan Hyland	01489 878724
TABLE TENNIS	Pete Woodacre	01489 877768
	Adrian Hunt	01489 878141
LADIES GROUP	Liz Whales	01489 877712
CONSERVATION GROUP	Phil Bergin	02392 632551
MEET&EAT	Sue Musselwhite	sue@poppyhill.net

Local History ... A Midnight Murder at Hambledon

The year was 1782 and precise times were not so important as they are in modern investigations but midnight does seem to be about the time the murder took place. Nearly a quarter of a century later the facts have got distorted and one can find many variations, even to the name of the victim, was it James or was it Nicholas Stares? The Soberton burial register of 23 August 1782 clearly states that it was James Stares and his gravestone is in the churchyard. The list of burials sent to the Bishop of the diocese annually actually has the following note "inhumanly murder'd by John Taylor of Hambledon".

James Stares, was the son of James and Mary (nee Arnold) believed to have been baptised in Soberton in 1737. He was married and had a young son, also James. His late father, or grandfather held land at Hoe Gate, Soberton and it is very likely that James still held that land. This partially would explain why he was in Hambledon on a market day.

Hambledon held an important position in this area as it was granted a weekly market in 1256 and later King James I granted two fairs per annum. Fairs would have brought a diverse section of people to the village from genuine traders to ne' do wells. The weekly market, held on a Tuesday, also attracted people from a wider area as it was a place to do business. Farmers from the neighbourhood might be there to buy or sell livestock while their wives sold poultry, eggs, fruit etc. and perhaps purchased something they could not get within their village. Agents from seed merchants, insurance companies and the like would be known to operate from a room in a particular public house of which there were probably a dozen in 18th century Hambledon. Inns and public houses, especially in rural communities, were often the venue for sale of property, land, buildings, timber etc. as new local newspapers were able to advertise the time and venue. They might also be used for public meetings, petty session courts and for inquests.

As James was at the New Inn, Hambledon on Tuesday the 20th Aug. he may well have been receiving payment for a deal on one of his crops. Money was evidently handed over to him and the transaction was witnessed by a third person most likely the murderer. Although some reports suggest that James was a farm labourer receiving wages for work done it is recorded that the buckles from the victim's shoes had been removed, a second piece of evidence to suggest he was not a farm labourer and that he, and the person he was doing business with, were probably not in the same room/bar as the regular clientele.

It is understood that James Stares left the New Inn at Hambledon about 11 30pm and was joined by a young blacksmith, John Taylor who lived near Hoe Cross and going in the same direction as James Stares. Why he should take a mop with him for a walking stick is not known. John Goldsmith in his book on Hambledon suggests Taylor had gone to the New Inn because of a barmaid he had fallen for but she did not return his feelings and so he was in a morose mood.

The pair walked down West Street until they came to a path that took them to the top of Cams Hill where the murder took place. Was it pre-meditated? Did Taylor pick up a mop for that purpose? It is reported that the mop was used with such force that the handle was broken but after that a knife was used to cut the victims throat from side to side and also from top to bottom. One explanation I have heard recently for this was that James Stares had been to America and never stopped talking about it. He was silenced by the murderer, So far no evidence to suggest he had been to America.

The following morning some men on their way to work stopped to examine a bloodied pile of rags on the roadside and found it was a man's body. They probably panicked and ran to Hambledon to get help. What happened next is not known. There was no police force, no Hampshire Constabulary to report the crime to. Each village was responsible for appointing a 'constable' from within the community, a position that was not welcomed and if the appointed could afford it he might well pay someone else to serve for him. Above him there would have been a local Justice of the Peace, a magistrate, nominated by the Lord Lieutenant of Hampshire and approved at a higher level. These men were selected from amongst the local gentry, John Goldsmith's ancestor could have been one of them.

It is likely that suspicion fell on John Taylor quite early in the investigations that followed as the two left the New Inn around the same time and were known to be going in the same direction. The unknown investigators went to the house where John Taylor lived with his widowed mother but no incriminating evidence found. The smock he was wearing the previous evening was later found at the blacksmith's shop

John ran for his mother in Hambledon. The bloodied garment had been hidden behind the forge but there is no information about the money or the shoe buckles. The rattled young man denied it was his but later his mother said the garment did belong to her son. As she had most likely made it and perhaps embroidered it, she would not be mistaken. Mr. Tribe, the Master of the New Inn and a maid also swore that it was the frock* that Taylor had worn the previous night.

According to a report on the 24th August in the Hampshire Chronicle "at 7 o'clock on Friday evening a blacksmith from Hambledon was brought to our County gaol charged with the wilful murder of Mr. Stares of Soberton." Where had John Taylor been in the meantime and under whose watchful eye?

John was committed to trial at the next Assize but it seems that it was at the Assize in March 1783 that the penalty was issued – execution and "the body to be dissected and anatomised". John never admitted his guilt. The smithy at the foot of Cams Hill where John was arrested was taken over by his younger brother Robert and his descendants had a forge there into the 20th century.

The Stares family had sufficient money to pay for a tombstone in Soberton churchyard with a thought provoking inscription. A memorial stone was also erected on the spot where the murder took place on Hambledon Lane. Over the years the stone has been defaced and now lies in several pieces despite it apparently being a listed monument.

**A round frock was a particular kind of smock*



Soberton & Newtown Local History Society

As this is written, the Society's Annual spring 4 day trip in April, is still fresh in everyone's minds. This year we were based in Bedford, and spent a day at Bletchley Park, home of the Codebreakers in WWII. What a fascinating place – and a whole day was needed there to take in everything. We also visited the Shuttleworth Collection and Swiss Gardens. This is a working collection of historic aircraft and vehicles and we were lucky enough to see several small aircraft from the middle part of 20thC or earlier, take off and land. Combined with the beautiful gardens, there was something for everybody! Other visits were to Wrest Park with its stunning architecture and interiors and Ascott House, a much cosier house completely remodelled by The Rothschild family in Victorian times to resemble a black and white Tudor House. The gardens there were also stunning – much enhanced by the weather for the whole trip which was warm and sunny!

14 of us made the trip this year and we look forward to what's in store for next year! Like the sound of it? Do come along to the History Society and join us for next year's Spring trip!

Back to the summer programme of events. It's at this time of year that the Society likes to get out and about and so on Thursday 11th June, we have a guided walk around Titchfield Abbey. Our July visit is on 9th July and is a visit to Amberley Museum, near Arundel. If you are interested in any of these visits, which are open to Society members, please do get in touch!

Summer Show

Meon Hall, Pound Lane,
Southampton, SO32 3NP

Sunday 19th July 2026

13.30 - 16.00

**£1.00 Entry Fee - Children
free (bring cash)**

Displays of:

Flowers

Vegetables

Fruit

Cookery & Crafts

Entertainment:

Produce & Plant stalls

Raffle

Live music

Beer & Pimm's tent

For more information & entry forms
for non-members

visit: droxfordparishcouncil.gov.uk



In your garden ... muck management

This time last year I was harking on about how water was in short supply in our gardens and should be rationed. I imagine that will be true again this summer, but it is becoming more apparent with each passing year that as far as water goes, it is very much a 'feast or famine' situation. The ability to retain water in butts, tanks or even swimming pools converted to store rainwater – more than one property in the Meon Valley has done this clever conversion – is an essential part of maintaining the hydration of your borders.



This year, after swimming through some gardens during the floods, one of which had a literal ankle-deep river running through it with blanket weed forming towards the end of the season, it made me realise, even more now than ever, how important the soil in our garden is.

We call it by a multitude of names, one of which is dirt, which sounds awfully derogatory for something which sustains life and produces so much beauty. I think many of you who have read this far into the article will be of the opinion that the soil around us is of huge importance, and as gardeners or at least people who own gardens, it is a responsibility to maintain or even improve it.

I'm very fortunate to work in gardens across the Meon Valley that predominantly have well established gardens, custodians who deeply care about them and invest in the soil.

How do we 'invest' in soil? ISAs? Stock market? It's quite a bit more straight forward than that, we compost!

The first part of 'soil management' is knowing what you have beneath your feet. Living in the Meon Valley, you are, according to LandIS: soilscape 3 which means we have a shallow lime-rich soil over chalk and limestone. It is freely draining and has a slightly above average fertility rating. It also means that any chemicals that are used will drain quickly into the surrounding chalk stream, so we need to be doubly careful about what we are using in our gardens and fields.

Composting can seem like witchcraft at times, and I know I have bamboozled some people in the past as it is something I have researched deeply. In the winter we get a lot of 'browns' which is woody materials from pruning fruit trees and large shrubs etc. In the summer we get lots of 'greens' which is grass cuttings etc. Ideally, we would create a lasagna style formation in our compost bins where a thin layer of 'green' and a thin layer of 'brown' are put on top of each other to increase airflow and reduce chance of rotting as opposed to decomposition.

If I could make one suggestion it would be to limit the amount of pure grass cuttings that go into a compost. They rot down, minimise airflow and start to smell – if the compost smells strong, you need to turn it. If you need help with your compost or starting a compost, please feel free to get in touch.

The Tudor Gardener



On Saturday 27th June 2026, the nation commemorates Armed Forces Day which is an occasion to mark the contribution made by past and present Servicemen and women. Details of events are at armedforcesday.org.uk.

The threat to the United Kingdom, her overseas territories and global interests is at its highest since the Cold War. Simultaneously, the future of the North Atlantic Treaty Organisation (NATO), whose very existence helped end the Cold War, is uncertain with its key player (USA) threatening to withdraw from the alliance and European nations having to face the challenges of a resurgent Russia, possibly alone.

Mismanaged by successive governments, our armed forces have been allowed to decline and reduced in size by some 50-75% over the past 30 years. Recently and notable to the casual observer, was the apparent difficulty for the Royal Navy to find a single air defence destroyer to help defend the Sovereign Base Area in Cyprus. Destroyers and frigates are the workhorses of the fleet, but numbers have dwindled from about 50 in the early 1990s to just 13. Based on the 'rule of thirds' ($\frac{1}{3}$ operational; $\frac{1}{3}$ preparing for or returning from operations or undergoing routine maintenance; $\frac{1}{3}$ in refit), this means we're lucky to have 4 operational escorts available at any one time. The 6 Type 45 destroyers have also been afflicted by poor design and a protracted project to upgrade their electrical power generation. In the end, *HMS Dragon* was brought out of refit early with work, intended to take a further 6-8 weeks, completed in just 6 days. The original requirement for 12 Type 45s might have avoided the situation.

A declining force of 7 from an original class of 16 Type 23 frigates is also of major concern. Designed for a working life of 18 years, all are now well over 20 years old (many older than the average age of their ships' companies) and, consequently, are difficult and expensive to maintain. Delays in ordering replacements will mean that it will be the mid-2030s before the planned 8 Type 26 anti-submarine frigates and 5 Type 31 general purpose frigates are in commission. This will bring the total escort force to 19 with the Type 45 destroyers due for replacement by 2038. We really need at least 25 escorts, so let's hope there are 12 replacements for the Type 45 but don't hold your breath!

Submarines are also an issue with, currently, only one nuclear attack submarine (SSN) operational from a force of 5. Two more are building but we need 12 SSNs to ensure at least 4 are operational. Such an uplift is constrained by the capacity of our single submarine builders at Barrow who also need to complete 4 Dreadnought class ballistic missile submarines (SSBNs) to replace 4 ageing Vanguard class boats by the mid-2030s.

The Army and RAF have fared no better. With only a little over 70,000 personnel, the British Army has reached its nadir and would have difficulty deploying and sustaining even a single armoured brigade. Meanwhile the RAF has reduced from about 800 combat aircraft to just 150 since the 1990s. Of these, about $\frac{1}{3}$ are F35B Vertical Short Take Off and Landing (VSTOL) strike fighters which are fundamental to generating the fighting power of our Queen Elizabeth class aircraft carriers.

Our armed forces continue to display qualities that show Britain at her best but, without sufficient people and equipment, they are struggling. They need your support – and your taxes!



The RBL Droxford & District Branch is always looking for new members, both Service and civilian, to help keep remembrance alive and support our Servicemen and women, veterans and their families. For more information or to join us, please contact the Secretary – Cdr Rob Scott RN at robmunroscott@aol.com or 01489 877800. www.soberton.org/rblweb.

Please e-mail copy for the August / September magazine to

gill.highcroft@btinternet.com

NEXT COPY DATE - 20th July 2026 (17:00)



June and July

June drifts in on a soft-spoken breeze,
A painter of long days and honey-gold ease.
She scatters wildflowers along every mile,
And teaches the sunlight a slower-burn smile.

July arrives louder, a spark in his stride,
Fireworks tucked in his pockets with pride.
He turns up the heat till the evenings glow red,
And laughter runs long where the daylight once led.

June hums in pastels; July sings in flame.
Two summer siblings with rhythms the same.
One whispers "begin," the other shouts "alive,"
Together they make the warm world thrive.

And when they pass by, hand brushing hand,
They leave a bright shimmer across the whole land—
A promise that warmth always circles back through,
In the footsteps of July, in the memory of June.

*The Parish Magazine team would like to
say a BIG thank you to our secretary*

Paula Hobbs

*who is standing down for some very happy
family reasons!!!*

*Paula has single-handedly succeeded in
getting the team together for the occasional
meeting and organised the last distributors
thank you lunch.*

*Paula – thank you for everything you have
done – you will be missed!!*

Soberton Parish Council: Annual Parish Report 2025-2026

www.facebook.com/SobertonParishCouncil
Website - www.soberton-pc.gov.uk



New Website

Launched last month and developed over the past six months the website provides up to date information and links for further information, comments, reporting incidents etc. The website is easy to navigate and will be managed and updated regularly by the parish clerk. The parish have social media pages and use local social media to advise of events etc.

Finances

The Parish Precept for 2026/2027 has been approved and is detailed in the accompanying financial report. The Precept is used for maintenance at the Recreation Ground (upgrading as necessary), local support grants (maintenance contributions for the church yards for example), administration of the council (the clerk's salary for 10 hours a week, printing etc). Local grants are applied for on an ad hoc basis,

Soberton Recreation Ground, Heath Road

The field of play for the football pitch is beginning to establish itself, and we are hoping that the grass is of sufficient strength to allow games from the beginning of next season this coming September. A detailed tree survey was carried out across the recreation ground and work required to many trees will commence shortly. A new defibrillator, which is being supplied by a local group, is to be installed at the Pavilion. The PC has applied for an infrastructure CIL grant for a proposed outline plan which would include an all weather circular path and a young persons 3 to 13 year old children play area, together with improvements to boundary railings and fencing.

Roads, footpaths and bridleways

This winter has taken its toll on many of the roads/lanes through the village. HCC Highways maintenance teams have been busy carrying out repairs. Should you wish to report a pot-hole you can do this via the HCC website and it will be acted on promptly.

The Meon Valley Trail suffered a number of fallen trees over the winter, all have now been cleared. We understand that parts of the surface are to be worked on during the summer to improve drainage. This is seen as an important route to access the Downs from the south.

The Droxford Splash Route (so called) is a section of the River Meon near Droxford Mill where historically vehicles, horse drawn carriages and horses are able to ford the river. Vehicles using the route are destroying 50 metres of important ecology on the river bed. The Meon, an important, nationally protected chalk stream is suffering. HCC and SDNPA are collecting evidence with the view to ban motorised traffic, there are alternative routes available.

There has been a noticeable increase of traffic in the parish, this is noticed particularly by those who live on 'through routes' where traffic crosses the parish. The PC has proposals to introduce 'village gateways' on Heath Road near the Buddens Lane junction and Church Road near Martins Corner. The gateways require HCC Highways approval and we are chasing this. The PC has two Speed Indicator Devices, both provide traffic speed data which the PC analyse regularly and use to make the case for traffic calming to HCC Highways.

Drainage/flooding

During January and February a few properties in the Parish were flooded. County Highways have cleared road culverts etc when alerted where problems arise. Some flooding is caused by water being restricted downstream of properties where it is a landowner's responsibility to clear any restrictions. Such work can be reinforced by HCC Flood Water Management team who can fine offenders.

Community Bus

The PC supports the Meon Valley Community Bus and will go on doing so as the bus provides a vital service for residents across the parish. The timetable is published in the Parish Magazine and can be accessed via the PC website.

General Planning Matters

The Parish Design Statement Group are making final adjustments to the Soberton Parish Design Statement 2026 following comments from the two planning authorities, and will hold a public consultation during the summer with the view of seeking adoption from WCC and SDNPA later this year. This has been a long process, the PC is indebted to Vicky Weston and Jonty Sherwill for their time and resilience in completing this task.

The Winchester District Local Plan 2020-2040 was formally adopted on March 24, 2026. The South Downs National Park Local Plan (review) 2019-2042 regulation 19 consultation is scheduled for this June/July with likely adoption in November 2026.

The PC is working with enforcement officers to highlight local matters and reinforce local concerns. Unfortunately it must be appreciated that in many instances enforcement is a lengthy process.

Elections and Local Government Reorganisation (LGR)

The Parish of Soberton has HCC and District Council elections on Thursday 7th May. There will be no Parish Council election this year as the parish has selected eight parish councillors via a non contested election. Those Parish Councillors standing down from this current council are John Russel Smith, David Cleeve and Kate Buttriss. I would like to take this opportunity to thank them for their work and support whilst they were Parish Councillors.

The government office for LGR has decided that the County of Hampshire will be divided into five unitary areas, these being; North Hampshire (Basingstoke, Hart and Rushmore), Mid Hampshire (New Forest, Test Valley, Winchester and East Hampshire/Petersfield), South West Hampshire, South East Hampshire and the Isle of Wight. Soberton Parish being in Mid Hampshire. The unitary areas will hold elections in May 2027, shadow the existing district councils for twelve months and be adopted in May 2028. The election for Mayor of the Hampshire Strategic Authority will take place in May 2028

Key Actions for 2026/2027

To progress Village Gateways, to complete the work to the recreation ground, to seek final approval and adoption of the Parish Design Statement and to monitor enforcement actions.

*John Hyland Chair
21st April 2026*

SOBERTON PARISH COUNCIL - councillors

<i>John Hyland</i>	<i>Chairman</i>	<i>chair@soberton-pc.gov.uk</i>
<i>Neil Findlay</i>	<i>Vice-Chairman</i>	<i>vicechair@soberton-pc.gov.uk</i>
<i>David Cleeve</i>		<i>Cllrcleeve@soberton-pc.gov.uk</i>
<i>Sam Marland</i>		<i>Cllrmarland@soberton-pc.gov.uk</i>
<i>Paul Henderson</i>		<i>Cllrhenderson@soberton-pc.gov.uk</i>
<i>John Russell-Smith</i>		<i>Cllrrussell-smith@soberton-pc.gov.uk</i>
<i>Jonty Sherwill</i>		<i>Cllrsherwill@soberton-pc.gov.uk</i>
<i>Vicki Weston</i>		<i>Cllrweston@soberton-pc.gov.uk</i>
<i>David Buttriss</i>		<i>Cllrbuttriss@soberton-pc.gov.uk</i>
<i>Kate Buttriss</i>		<i>Cllrkbuttriss@soberton-pc.gov.uk</i>
<i>Carol Williams</i>		<i>Cllrwilliams@soberton-pc.gov.uk</i>
Clerk and Proper Officer		<i>clerk@soberton-pc.gov.uk</i>

Winchester Councillor Update – Local Government Reorganisation

By the time you read this article, residents across the area will have voted for the very last time for councillors to Hampshire County Council and Winchester City Council as we currently know them.



Both councils are scheduled to close in April 2028, when a new Mid-Hampshire Unitary Authority will come into being. This is the biggest change to local government in our area for a generation, so we wanted to explain what is happening and why the next set of elections in 2027 matter.

What is changing?

At present, services are split between the county and district councils. Under the new arrangements, most local services will be brought together into a single unitary council for Mid-Hampshire. The aim is to simplify decision-making, reduce duplication, and make it clearer which council is responsible for what.

Why elections still matter next year

Although the new council will not formally operate until 2028, elections will take place next year. The councillors elected will:

- help design and oversee the transition to the new authority;
- ensure services and responsibilities transfer safely; and
- then serve a full four-year term running the new unitary council.

The 2027 elections will therefore play a key role in shaping how the new council works from the outset.

Benefits and risks

Unitary authorities can bring benefits, including improved coordination, greater efficiency, and clearer accountability. Many parts of England already operate successfully under this model. However, Mid-Hampshire will cover a very large and diverse area, and there is a real risk that decision-making could feel more distant from local communities. Protecting local voice and democratic connection will be one of the new council's biggest challenges.

Keeping decisions local

Options for the creation of local area committees to manage genuinely local issues such as highways priorities, environmental matters and community concerns will be a key consideration for the new unitary council. How much authority is delegated locally will be critical — and this will be strongly influenced by the councillors elected next year.

Looking ahead

Local Government Reorganisation brings uncertainty, but it will provide an opportunity to build councils that are efficient, transparent, better connected and responsive to local communities. We will continue to keep residents informed as plans develop and are always happy to hear your views.



Cllr Malcolm Wallace — MWallace@winchester.gov.uk

Cllr Danny Lee — dlee@winchester.gov.uk

Cllr Suzanne White — swhite3@winchester.gov.uk

The cuckoo is back

The call of the cuckoo 'cuck-oo, cuck-oo' is one of the most evocative sounds of spring, carrying over open countryside, reedbeds and edges of woodland. Males are the first to return and they waste no time announcing their presence loudly as they establish territories and attract females.

The cuckoo (*Cuculus canorus*) has a grey head, barred underparts and bright yellow eye-ring. Sleek and falcon-like, it has pointed wings that droop slightly when perched and a long, graduated tail. It gives an uncanny resemblance to a sparrowhawk in flight and the two are often confused - look at the tail to help distinguish between them.

The cuckoo has an extraordinary breeding behaviour. Rather than building a nest, cuckoos are brood parasites, laying their eggs in the nests of other birds such as reed warblers, meadow pipits and dunnocks. The female waits patiently for her moment, often when the host is away, before swiftly laying a single egg. Remarkably, these eggs often closely resemble those of their host species.

Once hatched, the young cuckoo wastes no time. Using a remarkable instinct, it pushes any other eggs or chicks out of the nest, ensuring it receives all the food brought by its unsuspecting foster parents. Its loud begging call mimics a whole brood of chicks, prompting the adults to work tirelessly, even as the young cuckoo grows far larger than them.

Cuckoos are also valuable insect hunters, feeding largely on invertebrates, with hairy caterpillars a particular favourite - prey avoided by many other birds.

Cuckoos are long-distance travellers, spending the winter in sub-Saharan Africa before returning to the UK in spring. Their stay is short-lived: many adult cuckoos begin their return journey south as early as late June, with young birds following weeks later on an instinctive migration to Africa.

Sadly, the cuckoo's call is no longer as widespread as it once was. Declines in UK populations are linked to habitat loss, pressures on their host species and challenges along migration routes.

Hampshire & Isle of Wight Wildlife Trust works to drive nature's recovery by restoring and protecting vital habitats, from reedbeds and wetlands to woodlands and grazing marshes, supporting cuckoos and the species they depend on. By restoring these habitats at scale and creating richer, more connected landscapes, the Trust is helping ensure that this much-loved sound of spring continues to echo across our countryside for years to come. Find out more about how to support the Trust by joining as a member on the Trust website: hiwwt.org.uk/support-us



Photo: Jon Hawkins_Surrey Photography



**Hampshire &
Isle of Wight
Wildlife Trust**

Meon Valley Carers Group

For carers of someone with Dementia
Receive support, information and signposting
Meet and talk to others carers in similar situations

4th Tuesday of each month 2pm - 4pm

at The Paterson Centre, Church Road, Swanmore, SO32 2PA

The programme for these meetings is varied with speakers ranging from necessary, interesting, factual information to more lighthearted subjects.

Built into the group meetings are arts and crafts, musical afternoons and games suitable for those living with Dementia.



You will be given a warm welcome!



Tea coffee and biscuits provided

Free parking in the car park opposite the Paterson Centre

For more information, please contact

Allison McNally

tel: 07771 895370

e-mail: allison.mcnally1968@gmail.com



Meon Valley Heartstart are a small and friendly group of volunteers providing free training sessions on how to save a life



We teach CPR, how to use a defibrillator and more!

Could you spare a little time each month to help us?

We have various positions available including;

- Lead trainer
- Admin support
- Equipment coordinator
- Course Assistants
- Medical Support Coordinator
- Fundraisers



To register interest or for an informal chat, contact David on 07730 148920 or email info@heartstartmeonvalley.co.uk

www.heartstartmeonvalley.co.uk

EatSTreat

BISHOP'S WALTHAM FOOD FAYRE

Discover unique bites and local produce at our first ever evening food fayre in Bishop's Waltham High Street. Local suppliers of food, drinks, produce; late night shopping and much more.



FOOD | SHOPPING | ENTERTAINMENT

THURSDAY
18TH JUNE

FREE
ENTRY

6PM - 8PM

More Information: www.lovebishopswaltham.com

A Bishop's Waltham Town Team Event



Guest Speaker
Ian Howard:
"The Truth is
Black and White"

Thursday 4th June 2026 at 7:30pm

Ian's talk will give an overview of the theory of black & white photography along with tips and advice on processing and presenting images, including the journey of several images from the initial RAW image, to the final black & white version. Ian will also discuss the various "ideal" black & white subjects areas.



Bishop's Waltham
Photographic Society

St Peter's Church Hall, Free Street, Bishop's Waltham, SO32 1EE

Non-members are welcome (entry fee £5).

bishopswalthamphotosociety.co.uk



GIVE & TAKE

BISHOP'S WALTHAM

Help us to reduce waste in our town!

27th June 2026 - 10.30am to 2.30pm
St George's Square, Bishop's Waltham

A FREE EXCHANGE STALL
YOU CAN GIVE, YOU CAN TAKE,
OR YOU CAN GIVE AND TAKE.



Holiday, Travel, and Sports



Brought to you by
The Bishop's Waltham Town Team



GIVE & TAKE

BISHOP'S WALTHAM

Help us to reduce waste in our town!

25th July 2026 - 10.30am to 2.30pm
St George's Square, Bishop's Waltham

A FREE EXCHANGE STALL
YOU CAN GIVE, YOU CAN TAKE,
OR YOU CAN GIVE AND TAKE.



Toys, Games, Books and Clothes for under-11s



Brought to you by
The Bishop's Waltham Town Team



MVARA on the Road!

In April, MVARA members set off for two thoroughly enjoyable days out! The first trip was to Uppark House and Gardens where the group was given an excellent tour of the house and learnt a great deal about the previous owners, their lives and the impact they had on the building. This was followed by a garden tour with fabulous views across the South Downs.

"This was a most enjoyable and interesting day, visiting a beautiful property with good company. The welcome chocolate, when we got on the bus was such a thoughtful gesture"

A few days later, it was off again, this time to see Jane Austen's Cottage at Chawton.

"Another lovely visit with a jolly lunch enjoyed afterwards in the local pub gardens where there was much discussion about Jane and her works"

On both occasions transport was again provided by The Meon Valley Bus, a great way of getting around the Meon Valley and neighbouring locations (see next page for details).

For more details of MVARA activities visit www.mvara.co.uk



Meon Valley
Active Retirement
Association

MEON VALLEY LIONS CLUB

Date for your diary - Swanmore Village Fete – Saturday 11th September

Join us

If have some time to spare and would like to help local people, either joining as Club member or just an occasional helper at our events, then please call us on 07443 753780 or via our website www.meonvalleylionsclub.org.uk





www.meonvalleybus.co.uk
info@meonvalleybus.co.uk

Timetable from July 2025

Mondays West Meon to Fareham

0930	West Meon Thomas Lord PH
0933	Warnford Village Hall
0938	Exton The Shoe PH
0940	Meonstoke PO & Stores
0944	Meonstoke Pound Cottages
0951	Droxford Square
0955	Brockbridge The Hurdles
1000	Soberton Village Hall
1003	Webbs Green War Memorial
1006	Soberton Heath Chapel Road Pond
1008	Soberton Heath Bold Forester PH
1010	Newtown Rookesbury Hall
1015	Hundred Acres
1027	Fareham Library
1032	Fareham Station <i>Drop off only*</i>
1039	Fareham Sainsbury's
Return:	
1230	Fareham Sainsbury's
1235	Fareham Library

Wednesdays Soberton to Petersfield

Including all request stops on A32 Droxford- West Meon

0930	Soberton Village Hall
0934	Brockbridge (The Hurdles)
0939	Droxford Square
0946	Meonstoke Pound Cottages
0951	Corhampton
0954	Warnford George and Falcon
1013	Petersfield Station <i>Drop off only*</i>
1017	Petersfield Square
1022	Petersfield Tesco
Return:	
1225	Petersfield Tesco
1230	Petersfield Square

Fridays Soberton to Winchester

0930	Soberton Village Hall
0934	Brockbridge The Hurdles
0939	Droxford Square
0945	Meonstoke Pound Cottages
0949	Meonstoke PO & Stores
0951	Exton The Shoe PH
0956	Warnford Village Hall
1016	Winchester Broadway
1023	Winchester Station <i>Drop off only*</i>
1030	River Park Leisure Centre
Return	
1225	River Park Leisure Centre
1230	Winchester Broadway

No service on other days or public holidays. £6 return, £3 single any journey. Bus passes accepted. Under 16 half fare. Under 5 free. Dogs allowed subject to driver discretion. Timings are strict, bus will not wait after scheduled time.

A FEW USEFUL NUMBERS

ANY ADDITIONS OR CHANGES, PLEASE CONTACT THE EDITOR

SOBERTON VILLAGE HALL BOOKING		sobertonvillagehall@googlemail.com www.sobertonvillagehall.co.uk 01329 834392
ROOKESBURY HALL BOOKING	Jenny Doney	Bookings@rookesburyhall.co.uk 01489 877430
GUIDE HUT BOOKING	Caroline Rogers	guidehutsoberton@gmail.com 07843 496852
GOOD NEIGHBOURS GROUP <i>OFFERS TRANSPORT TO MEDICAL APPOINTMENTS</i>	Kate Harvey Kate Chesters	07710 716664 See page 32 for more details
COMMUNITY SUPPORT OFFICER	Gary McCulloch ACSO	07442 156124 acso@swanmore.org.uk
CLERK AND PROPER OFFICER	clerk@soberton-pc.gov.uk	See page 41 for full list of Councillors
CENTRAL MEON VALLEY COUNCILLORS	Malcolm Wallace Danny Lee Suzanne White	See page 42 for contact details
COUNTY COUNCILLOR		-

From the Archives.....



Above left - The Murder Stone, pre-2020 before it was damaged. Sited near the top of Cams Hill, between Hambledon & Soberton, it marks the place where Soberton man James Stares was murdered while walking home in 1782. The inscription began "Let future generations know..." but the rest was lost to time and the weather. The stone was found damaged in 2020 and enquiries by Hambledon Parish Council and Historic England ascertained that it would cost £5000 to repair. No funds being available, members of the Stares family have replaced the pieces of the stone in the same position on Cams Hill with flower planting around it.

Above right - James Stares's grave in St Peters Churchyard, outside the East window. The inscription reads "SACRED With solemn thought survey this grave on the untimely death of thy fellow mortal, and whilst as a Man read of the inhumane narrative drop a tear for his family's loss. On 20th August 1782 JAMES STARES was murdered and robbed in the 46th year of his age.

The full story of James Stares can be found on pages 34 and 35 of the magazine.

(from the Archives of the **Soberton & Newtown Local History Society**) any additional information is always welcome.
Please Contact lyndonplmr@gmail.com or petewoodacre@gmail.com



andrew & andrew

solicitors

FOR TRUST. FOR ADVICE. FOR LIFE.



WICKHAM

11, The Square, Wickham, Fareham,
Hampshire, PO17 5JQ
Tel: 01329 623 322

PORTSMOUTH

Atlantic House,
114 Kingston Crescent,
Portsmouth, PO2 8AL
Tel: 023 9267 5555

EMSWORTH

51 High Street,
Emsworth,
PO10 7AN
Tel: 01243 680 800

OUR SERVICES



Wills,
Probate,
Powers of Attorney



Family Law/
Matters



Residential
Conveyancing



Personal
Injury



Contentious
Probate



Employment
Settlement
Agreements