

# Soberton & Newtown

PARISH MAGAZINE For all the community, delivered FREE to over 700 households

October - November 2024



A peaceful evening ride  
Ingoldfield Lane  
Photo by Jonty Sherwill

[www.sobertonchurch.org.uk](http://www.sobertonchurch.org.uk) [www.newtownchurch.org.uk](http://www.newtownchurch.org.uk)

Front cover design: Jonty Sherwill

## **St. Peter's, Soberton and Holy Trinity, Newtown.**

For details of **CHURCH SERVICES**, please refer to page 4

For any enquiries, please contact the following

### **Benefice of Soberton, Newtown and Hambledon**

Priest in charge of Meon Valley Parishes

Revd Andy Davis

revd.andydavis@gmail.com

07709 919602

Curate of Soberton, Newtown and Hambledon

The Reverend Liz Quinn

elizabeth.quinn7@btinternet.com

07769 700960

### **Licensed Lay Minister (Reader)**

Norman Chapman, Meadow Cottage, West Street, Soberton 01489 877378

e-mail: norman@soberton.org.uk

### **Our Lady Queen of the Apostles, Roman Catholic Church**

St. Martin's Street, Bishop's Waltham, SO32 1DN

**Father Bruce Barnes (brucebarnes01@gmail.com) 01489 890947**

6.00 pm Saturday (First Mass of Sunday)

9.30 am Sunday

There are Sunday evening services in Winchester and in Fareham.

For further information, please contact Anthony McEwen 01489 877448

## **MAGAZINE PRODUCTION & COMMITTEE**

<b><u>Chairman</u></b>	Perry Abbott	02392 632338	<b>cpgabbott@hotmail.com</b>
<b><u>Editor</u></b>	Gill Gray	07711 058760	<b>gill.highcroft@btinternet.com</b>
<b><u>Advertising</u></b>	Kate Buttriss	07801 441998	<b>kate.buttriss@gmail.com</b>
<b><u>Circulation</u></b>	Pete Woodacre	01489 877768	<b>petewoodacre@gmail.com</b>
<b><u>Treasurer</u></b>	Anthony McEwen	01489 877448	<b>anthony.mcewen@btinternet.com</b>
<b><u>Secretary</u></b>	Paula Hobbs	07469 258022	<b>paulajhobbs@live.co.uk</b>

**Typesetting of adverts and printing:** Solent Design Studio **solentdesignstudio.co.uk**

**Front cover design:** Jonty Sherwill 01329 835161 **www.sherwilldesign.com**

## Contents

- 4 ❖ The Benefice of Soberton, Newtown & Hambledon – Services
- 5 ❖ Stir-up Sunday – Holy Trinity
- 6 ❖ Foreword ...from Rev. Liz
- 6 ❖ News from the Pews of St Peter's
- 7 ❖ Soberton Players - Treasure Island
- 8 ❖ Harvest Festival – Holy Trinity
- 8 ❖ Ploughman's Lunch Christmas Fair – Holy Trinity
- 9 ❖ School registration and open days – Newtown Soberton, Meonstoke, Droxford
- 10 ❖ Grace at Roverway 2024
- 11 ❖ Parish Christmas Card 2024 PiNS
- 12-13 ❖ Under our noses....or above our heads (Sarah Barclay)
- 13 ❖ Murder at the Village Hall
- 14 ❖ News from C.A.N.S.
- 15 ❖ Soberton & Newtown Local History Society
- 15 ❖ Soberton & Newtown Ladies Group
- 16 ❖ Road Report
- 17 ❖ Just one more year!
- 17 ❖ Meet&Eat
- 18-33 ❖ Classified Adverts – please support our local businesses
- 34 ❖ What's on (Village Diary)
- 35 ❖ Give way together! Charles Wylie rows ...
- 35 ❖ Meon Valley u3a
- 36 ❖ A SNUG Update
- 37 ❖ SNUG 'Bags of Love'
- 38 ❖ In your garden ... Getting Ahead
- 38 ❖ Meon Valley Garden Club – Autumn Plant Sale
- 39 ❖ RBL - Droxford & District Branch
- 40 ❖ Local History - Mrs Hants ..... in Soberton
- 40 ❖ Soberton and Newtown Good Neighbours Group
- 41-43 ❖ The Meon Valley Parishes ... Finding a new way of working
- 44-45 ❖ Soberton Parish Council - Chairman's notes
- 45 ❖ Mad dogs and Children's Week go out in the midday sun!
- 46 ❖ Droxford Christmas Market
- 46 ❖ Botley Choral Society
- 46 ❖ Meon Valley Carers Group
- 46 ❖ Wickham Society Autumn Programme
- 47 ❖ Winchester City Council – District Councillors
- 48-49 ❖ Hampshire County Council
- 49 ❖ Pop in for coffee & cake at St Peter's
- 50 ❖ Meon Valley Community Bus Timetable
- 50 ❖ Meon Valley Community Bus Annual Public Meeting
- 51 ❖ Useful information
- 52 ❖ From the Archives

**Please e-mail copy for the December / January magazine to  
[gill.highcroft@btinternet.com](mailto:gill.highcroft@btinternet.com)**

***NEXT COPY DATE - 11<sup>th</sup> November 2024 (17:00)***

**The Benefice of  
Soberton,  
Newtown &  
Hambledon**

**Services**

**October 2024  
November 2024**

*Subject to change,  
sometimes at short notice*

*Holy Communion or Morning  
Prayer is celebrated every  
Wednesday at 0930 at  
Hambledon with a short  
service of reflection at 1715.*

**OCTOBER**

6th	0800	Holy Communion	Hambledon
	1000	Holy Communion - Harvest Festival	Newtown
	1030	Short Family Service	Hambledon
13th	1100	Holy Communion	Soberton
	1100	Holy Communion	Hambledon
20th	0930	Holy Communion	Newtown
	1100	Service of the Word	Hambledon
	1100	Morning Worship	Soberton
	1830	Taizé	Hambledon
27 <sup>th</sup>	1100	Holy Communion	Hambledon
	1800	Holy Communion	Soberton

**NOVEMBER**

1st		All Saints	
2nd		All Souls	
3rd	0930	Holy Communion	Newtown
	1100	All Saints Holy Communion	Hambledon
	1800	All Souls Service	Soberton
	1830	All Souls Evensong	Hambledon
10th		Remembrance Sunday	
	1040	RBL Service	Soberton
	1045	Act of Remembrance	Hambledon
	1105	Service of Remembrance	Hambledon
17 <sup>th</sup>	0930	Holy Communion	Newtown
	1100	Service of the Word	Hambledon
	1100	Morning Worship	Soberton
24th		Christ the King	
	1000	Holy Communion & Stir up Sunday (see below)	Newtown
	1100	Holy Communion	Hambledon
	1800	Holy Communion	Soberton

**Come and have a Big Stir on Stir-up Sunday  
Sunday 24th November  
Holy Trinity, Newtown at 10am**

*led by Reverend Andy Davis*

**Come and have fun at Christmas Cake Making**

We will be creating cakes one for Holy Trinity and one for St Peters in church for sharing with the church and community.

People will be asked to bring along particular ingredients to make these Special Cakes, then they will all go into the bowl for one big stir-up during the Service!

The baked cakes will be returned to the churches for a celebration taster at the Carol Service at Soberton and on Christmas Day at Newtown.

All enquiries to Sue Wells: 01329 834130 [sjwells@meonwood.co.uk](mailto:sjwells@meonwood.co.uk)



## ***Foreword ... from Rev. Liz***

As we come to September I begin to feel a change in the weather. I notice too that the evenings are drawing in. As I walk around my garden I see that the leaves are beginning to fall from the little Acer tree. I'm not one who immediately loves the move towards Autumn. I'm already missing the bright evenings; the expectation of warm months to come and the abundance of new life in the flower beds.

As the days move on I realise that not all is as glum as I am imagining. The colours of autumn are ravishing, cascading from the trees and bushes. Even the little pink cyclamen hidden away in the longer grass are a joy to spy.

As autumn progresses, I take out my secateurs to address the long withering leaves of the gladioli. I take time to reflect on what has been. The flamboyant spears of flowers, red, yellow, peach, white standing to attention on parade. Continuing that military association, I remember that gladiolus comes from the Latin word gladius which means 'little sword'. I think 'large sword' would be more appropriate for my beauties!

As I snip away, I have an image of the little corms or bulbs which have produced such magnificence. The russet nobbles are now hidden away in the dark soil, buried, apparently lifeless. They will lie there through the frosts and frozen ground, almost forgotten. In my garden bed there's a large empty space.

This image reminds me of Jesus, buried deep in the cold, dark tomb. His friends were lost without him. There was an empty space in their lives.

For my gladioli corms, maybe they are not just buried. I might think of them cosily tucked into their garden bed, enjoying a well-earned rest! They won't spring to life again without that refreshing slumber.

I think there may be something in this image for us. Do we need times of rest and recuperation? Do we need a time of restoring our bodies, minds and spirits? A fallow time?

I wonder whether God, our Creator, understands this need for rest in all of his creation. God appears to have built in a facility for rest into creation. Whether this is our daily period of sleep, the longer period of hibernation for squirrels, or the

buried rest of my gladioli corms. What comes with a period of rest or fallow time?

I have hope that as spring dawns a resurrection occurs. The sword-like shoots of my gladioli will emerge through the soil of my garden bed. New and abundant life!

As we take a fallow time, to rest and recuperate, we might experience loss, as the friends of Jesus did. Loss of things or ways of being that we've always held on to but maybe seem unnecessary now. But working through this loss, we might see our own signs of new life. New shoots emerging. Flower buds beginning to grow. We are as varied as the colours of the gladioli. We wait and watch in expectation for our particular signs.

After the loss and time of waiting, the friends of Jesus experienced over-whelming new life. They had mourned the passing of their friend, Jesus. Then in some seemingly inexplicable way, he rose to new life from his burial tomb. Their lives were changed for ever. We can read more about that in the New Testament. Suffice to say, it's a story worth reading! And not just once. Jesus speaks to us through their story, which is his story. It can become our story, time and time again.

As we move into this fallow season of Autumn, I invite you to enjoy your own moments of rest and reflection. Maybe you enjoy pottering in your garden, going for a walk or opening your window to look at the view. What catches your eye; a last flower, a brown leaf, a buried corm? Rest with the image....



*Rev Liz Quinn  
Curate Meon Valley Parishes*

# News From the Pews (of St Peter's)

## A Joyful Month

July and August were wonderfully joyful months at St Peter's. The normal round of funerals was replaced by 2 lovely celebrations – both of which look to the future.

The first was the wedding of local lass Sabrina Morse to Joe Patching on 27<sup>th</sup> July. The church was full, the flowers (arranged by a professional team organised by Amanda Morse, the Bride's mother) were stunning and the bride looked as beautiful as the day!

The second was the baptism of baby Aria Easton on 31<sup>st</sup> August. Again the family was lucky with the weather and the church was full with friends and relatives. A later celebration at the White Lion rounded off the proceedings in traditional style.

## Wall Paintings in St Peter's

The magazine's June/July edition contained a few words about some lesser-known aspects of St Peter's. Many will be familiar with the fact that our wall paintings include depictions of St Catherine of Alexandria, St Margaret of Antioch and, possibly, St Barbara. However, I doubt many know much about these particular saints all of whom were removed from the general calendar only to be restored again in the early years of this century.

Research reveals that these are among the best known of the 14 Holy Helpers whose intercession was much valued in the Middle Ages and up to the reformation. Each Holy Helper had relevance to particular aspects of life and worshippers would pray to them for assistance when in trouble or ill. All were martyred for their faith though the stories which lie behind their martyrdom may seem somewhat unlikely.

Taking the 2 central paintings, reading left to right as one views them in the Curl Chapel, we have:

1. St Catherine of Alexandria - reputedly martyred by the Emperor Maxentius for refusing to deny her Christian faith. In an effort to convert her the Emperor gathered 50 of his best philosophers to argue with her; they in turn became Christians and were promptly executed. A determined Maxentius then tried to marry her. She refused him so he attempted to execute her on a spiked wheel (hence the Catherine Wheel firework). This promptly shattered. She was then beheaded. In our wall painting the Emperor's head is under St Catherine's feet – symbolising her Christian triumph.

St Catherine with her spiked wheel by Raphael



St Margaret standing on the dragon



2. St Margaret of Antioch – A very holy lady she was wooed by the Roman Governor of the East but spurned his advances and refused to deny her Christianity. Accordingly she was cruelly tortured but during this period many miraculous incidents were reported. One story has her being swallowed by Satan in the form of a dragon. Luckily for St Margaret he found her and her crucifix so indigestible that he disgorged her. In our wall painting Margaret is standing on the dragon and one can make out its tail and part of its head by her feet.

St Catherine is patron of philosophers, students, wheelwrights and those who work with wheels. She is invoked against sudden death and diseases of the tongue.

St Margaret is patron of women in childbirth and invoked against back ache or escape from the devil. She is reputedly one of the saints who spoke to and inspired Joan of Arc.

**Louise & Anthony**

**Well shiver me timbers...  
Soberton Players presents**



# Treasure Island

**A Pirating Panto Adventure!**  
by Ben Crocker

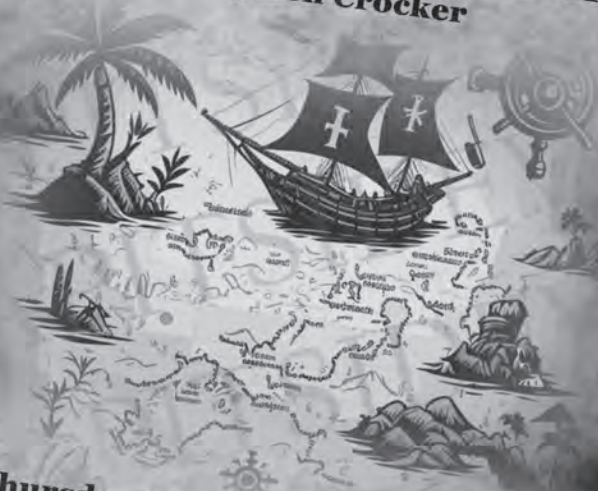

**Thursday 28th November 7.30pm**  
**Friday 29th November 7.30pm**  
**Saturday 30th November 2.30 & 7.30pm**  
**Soberton Village Hall – SO32 3PF**

**Tickets £10 (adults) & £6 (children)**

**Box office: 01489 878184 / 07866 931487**

**email: [tickets@sobertonplayers.co.uk](mailto:tickets@sobertonplayers.co.uk)**

**Come along in fancy dress!!!!**

**2 course pre-show meal available at  
'Ye Olde White Lion' - £18.95 - 5-6pm - Book direct  
01489 877346 [info@thewhitelionsoberton.com](mailto:info@thewhitelionsoberton.com)**



**SCAN ME**

*Soberton Players are so looking forward to bringing you this hilarious take on a classic tale, Treasure Island – The Panto!*

*Rehearsals are underway but we are still on the lookout for new talent, both on and off stage.*

*In particular, we are looking to add some junior members to the show. There are some particular roles which really hit the spot if performed by younger talent! Interested?*

*Please contact [peter@brightspark.uk.com](mailto:peter@brightspark.uk.com) (07802 791615) and I'll send a summary of what's involved – it's going to be a hoot!!*

Please come and join us for

# Harvest Festival



*to give thanks for all God's gifts to us*

led by Reverend Liz Quinn



**Sunday 6th October**

**Holy Trinity, Newtown at 10am**

followed by drinks and canapés in our lovely churchyard

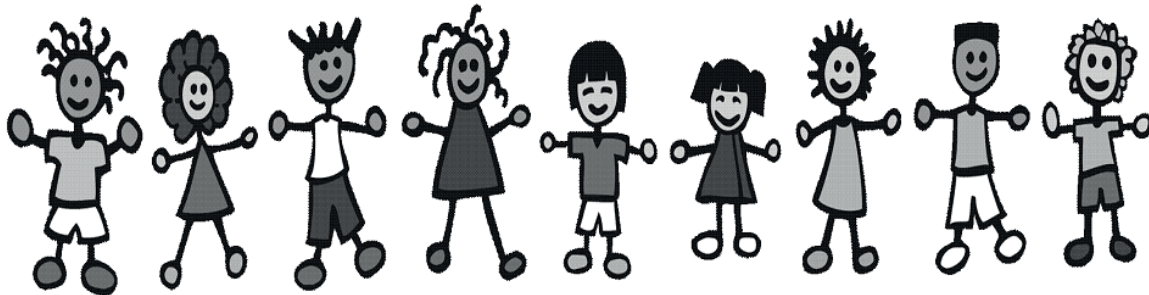

Holy Trinity Church, Newtown invite you to our biennial

## PLOUGHMAN'S LUNCH CHRISTMAS FAIR

Saturday 16th November 2024

12 noon

Rookesbury Hall, Newtown



Christmas Gifts \* Cakes \* Christmas Produce \* Draw

Adults: £10.00 to include soup, ploughman's, mince pie, glass of wine

Children: FREE

To help with catering please book tickets from Sue Wells either by phone: 01329 834130 /  
07850 011820 or email: [sjwells@meonwood.co.uk](mailto:sjwells@meonwood.co.uk)

Pay on the door!

Proceeds to Church funds

# Starting school in September 2025

If your child is 4 or will turn 4 before 1 September 2025, they can start school in September 2025.

For more information go to [www.hants.gov.uk/admissions](http://www.hants.gov.uk/admissions)  
Applications open for Hampshire residents on 1 November 2024

THE NATIONAL CLOSING DATE FOR APPLICATIONS  
IS WEDNESDAY 15 JANUARY 2025

**DON'T MISS IT!**



 Hampshire  
County Council

[hants.gov.uk](http://hants.gov.uk)

 Equipping our children with the  
knowledge and skills  
to navigate life successfully

## OPEN MORNING

Thursday 10th October, 10am

To find out more and see us in action,  
please contact our school office

Together we can offer an outstanding  
education for your child

t: 01489 877537  
e: [adminoffice@droxford.hants.sch.uk](mailto:adminoffice@droxford.hants.sch.uk)  
[www.droxfordjunior.co.uk](http://www.droxfordjunior.co.uk)

 Droxford Junior School, Union Lane, Droxford, SO32 3QR

## Newtown Soberton and Meonstoke Infant Schools

If your child is due to start school in September 2025, applications open via Hampshire County Council School Admissions on November 1st 2024, and close on 1<sup>st</sup> January 2025

Our open day events are listed below and we would welcome you to join us for one of our open events.

### Newtown Soberton



Open Morning  
24th September 9.30-10.30am

Open Afternoon  
14th October 2024 1.30-2.30pm

Open Morning  
22nd November 2024 9.30-10.30am

Open Afternoon  
10th December 2024 1.30-2.30pm

Please contact the school office  
[newtownadmin@meonvalleyfederation.co.uk](mailto:newtownadmin@meonvalleyfederation.co.uk)  
if you would like to book a place  
on one of our open sessions.

### Meonstoke



Open Morning  
26th September 2024 9.30-10.30am

Open Afternoon  
16th October 2024 1.30-2.30pm

Open Morning  
20th November 2024 9.30-10.30am

Open Afternoon  
12th December 2024 1.30-2.30pm

Please contact the school office  
[meonstokeadmin@meonvalleyfederation.co.uk](mailto:meonstokeadmin@meonvalleyfederation.co.uk)  
if you would like to book a place  
on one of our open sessions.

School registration and open days

Hi I'm Grace and I'm a leader at Soberton and Newtown Brownies. In July, I travelled to Norway with Girlguiding to be part of Roverway 2024. Roverway is a jamboree, meaning international guides and scouts meet for lots of exciting activities and adventures.

This year there were 6000 people, from 37 different countries taking part in Roverway. Participants were aged 16-22 and every country was made up of several patrols, the patrol I was part of was made of 7 guiders from South West England.



*South West England patrol with Gjøvik sunset behind*



*Opening ceremony in Stavanger*

The whole trip was 12 days long and was split into 2 halves. During the first week participants in their patrols were distributed all over Norway completing different activities. Our patrol was based in Gjøvik, north of Oslo, where we completed day hikes from our campsite each day, swimming in the lake and learnt pioneering and sustainability skills. Our diet wasn't very varied and consisted predominantly of bread, cheese and stew which although tasty can become boring quite quickly!

After our week in Gjøvik, we travelled 9 hours by coach to Stavanger, on the west coast of Norway. This is where the main campsite was located and where everybody joined up for the main jamboree event. An incredible opening ceremony got the week started with lots of singing, dancing and the lighting of a huge campfire. The week consisted of a large variety of activities including friendship bracelet making, canoeing, wood carving, sailing and scavenger hunts to name a few. We also spent a day in Stavanger itself, exploring the town and completing challenges. The weather was lovely for the second week which makes camping a much more enjoyable experience! We had a big closing ceremony to end the jamboree, where the campfire was lit again as well as more singing, dancing and games.

This was my first international event with Girlguiding, it was an incredible experience and I am excited to take part in more international adventures. I met so many guiders and scouts from across the world, learnt about their traditions and swapped lots of badges.

I hope you've enjoyed reading about my trip and maybe there will be inspired children or adults who would like to be involved with Girlguiding or Scouting so that they can be part of experiences like this!



*South West England patrol at opening ceremony*



*Sunset from jamboree site in Stavanger*

The Parish Magazine Committee was delighted to sponsor Grace on her fantastic trip! (£200)

# PARISH CHRISTMAS CARD 2024

**PiNS** (Pride in Newtown and Soberton) has for many years, with your generous contributions via the Christmas Card (printed in the next magazine), been able to carry out various projects within the villages. This year we have again worked with SoberNewts, and with the support of SDNP, planted more wild flowers in the village in various locations, including the High Street bank and in West Street. We have also arranged for BT to repaint the telephone box in Newtown, but sadly the one on School Hill is beyond repair.

Three fingerposts have been repainted in Hambledon Lane and near The Hurdles, and also the Soberton sign at Brockbridge has been restored and painted. This is in addition to the five fingerposts and two village signs that were renovated towards the end of last year.

If you would like to support PiNS in our work in the Parish and send Christmas greetings to your local friends and neighbours, saving the cost of cards and stamps, please send us your names as you would like to see them in the magazine and a donation. Also, if you have any suggestions for other projects you would like considered, please let us know.

All you need to do is, **before Saturday 2<sup>nd</sup> November** (so that there is time to prepare the card in time for the magazine copy date):

Either (**preferred option**):

Send a donation by BACS to the PiNS bank account and an email to **[helen.stranks@btopenworld.com](mailto:helen.stranks@btopenworld.com)** with details of how you would like your names to appear and how much you are donating.

Sort Code : 30-93-17  
Account No. 41179760  
Account Name : PiNS  
With your name as a reference

Or

Enter the names as you would like to see them on the 'card' on the slip below. Cut out the slip and put it, together with your donation, in an envelope (please make any cheques payable to PiNS) and put it through the letterbox of Helen Stranks, Ashley House, High Street, Soberton. SO32 3PN



✂-----

Names to Go in the 'Card' : .....

Telephone Number or Email Address : .....

Donation : .....

Other Projects to be Considered : .....

## Under our noses....or above our heads

If you are nose-y like me, and journalists and authors are always nose-y parkers, it is a pleasure when a bit of cursory digging, either in an archive or on the internet, results in a truly pleasing discovery. *Hampshire Days* is one such a find and thanks to this book, there is now even more of an excuse to curl up by the fire at night as the autumn starts to inspire an outdoor nose about.

*Hampshire Days* was originally published in 1903 and is an amazing social and natural history document. It won't be a quick read – but what it does provide is an extraordinary window onto nature in this county a century ago. The author, W. H. Hudson was born in Argentina but ended up in England which he loved. Impressed by Darwin, he journeyed around Hampshire at the turn of the last century, making observations (sometimes pretty unacceptable for modern sensibilities in his comments on his fellow humans) on the landscape, flora, fauna and people he met.

*Hampshire Days* may appear to be a bucolic stroll through our green and pleasant land over a century ago, but it is also the most amazing record of the prolific wildlife that existed and still does exist right under our noses and above us in the sky. This record was not lost on my nature-loving husband who, rather like Hudson, is always rummaging about, looking for bugs and birds.

A few years ago, much to his delight, he discovered a species of butterfly that was supposedly extinct from this part of the country. The finding of Brown Hairstreak butterflies in the hedges near our house was cause for celebration and then painstaking recording. Finding them and charting their number and egg laying habits became a weekend obsession. In the coldest months of the year, we stood, clipboards, ruler and tape measure in hand, recording the number of microscopic white eggs the Brown Hairstreaks had laid on nearby bare twigs Blackthorn bushes. Little bits of insulator tape were placed on their locations.

One particular January afternoon, as the temperatures dropped and what passed for sunlight that day had well and truly faded, we counted and recorded for what felt like hours. “Just a few more to go...not long now”. Numb toes, cold hands and in my case real self-discipline to remain assiduous (it is not a high-octane adrenaline sport counting and registering insect eggs) we plodded on.

There were many more than expected, which was good news for other species too. We weren't the only people giving them airtime or interest. Suddenly Brown Hairstreaks were flavour of the month. The local Butterfly Conservation group got very excited about the Soberton discovery and dispatched numerous enthusiasts to burrow around local hedges. The dull looking but important little butterfly even made it onto *The Archers* as a topic.

Daily we read and hear reports of the cataclysmic decline and in some instances decimation of species in our countryside, no thanks to pesticides and the destruction of hedgerows, but sometimes things appear to look up. Swallows have been everywhere and more numerous, certainly in our garden, this September. Perhaps it was the warm, damp air that produced delicious flies for their consumption. The swallows nesting in our shed have produced two batches of fledglings and this very evening, they are roaring around like junior pilots swooping and skimming inconceivably quickly before making their extraordinary journey to Africa.

W H Hudson enjoyed the same pleasures over a hundred years ago, albeit with now unimaginable quantities of birds, animals and insects. This scene below can just as easily be imagined standing on a little wooden bridge over the Meon.



*‘In days like these, so bright and peaceful, one thinks with a feeling of wonder that many of our familiar birds are daily and nightly slipping away, decreasing gradually in numbers, so that we scarcely miss them. By the middle of September, the fly-catchers and several of the warblers, all but a few laggards, have left us. Even the swallows begin to leave us before that date. On the 8<sup>th</sup> many birds were congregated at a point on the river a little above the village, and on the 10<sup>th</sup> a considerable migration took place. Near the end of a fine day a big cloud came up from the north-west, and beneath it, at a good height, the birds were seen*

*flying down the valley in a westerly direction. I went out and watched them for half-an-hour, standing on the little wooden bridge that spans the stream. They went by in flocks of about eighty to a couple of hundred birds, flock succeeding flock at intervals of three or four minutes. By the time the sun set the entire sky was covered by the black cloud, and there was a thick gloom on the earth; it was then some eight or ten minutes after the last flock, flying high had passed twittering on its way, that a rush of birds came by, flying low, about on a level with my head, as I stood leaning on the handrail of the bridge, shooting past my head with amazing velocity and a rushing sound, fanning my face with the wind they created, and some of them touching me with their wing-tips.'*



Happy autumn reading.

*Hampshire Days* by W H Hudson

**Sarah Barclay** is author of *Eden's Keepers, the lives and gardens of Humphrey Waterfield* and *Nancy Tennant* (Clearview Books)

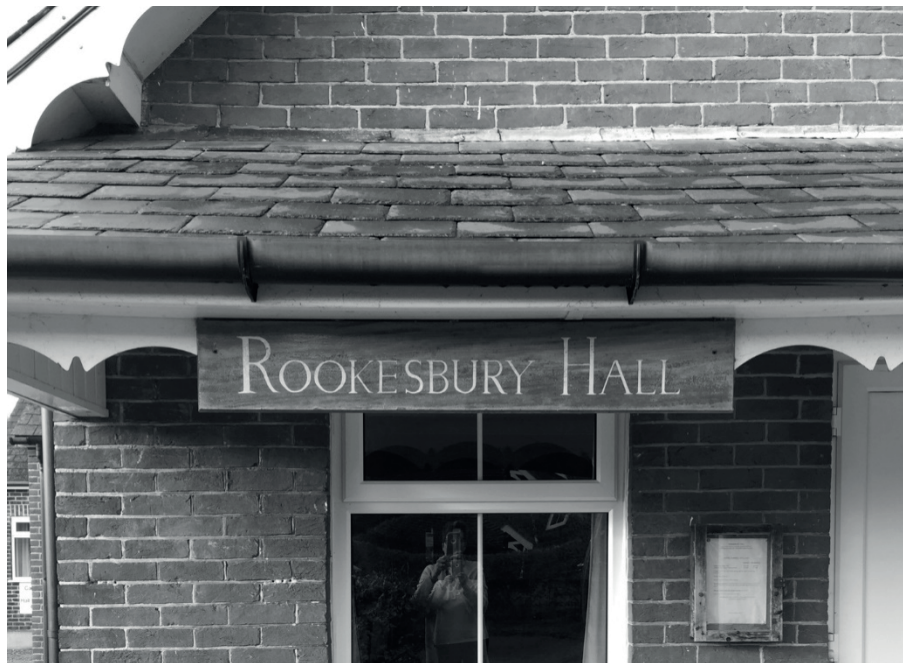

## **MURDER AT THE VILLAGE HALL**

Titchfield Festival Theatre and Rookesbury Hall invite you to join us  
for a murder mystery evening on

Saturday 12<sup>th</sup> October 2024 at 7pm

There will be a platter of food, please bring your own drink.

Tickets £20 per person.

Contact [info@rookesburyhall.co.uk](mailto:info@rookesburyhall.co.uk) to make a reservation.

# News from C.A.N.S- Autumn 2024

## (Climate Action for Newtown and Soberton)

### Visit to Hampshire Market Garden, Hambledon

At the end of July, members of C.A.N.S and SoberNewts went on a trip to Rushmere Farm in Hambledon for a tour and talk at the Hampshire Market Garden.

**Farm tour:** The farmer, George, showed us around, explaining his methods to achieve productive farming alongside abundant nature. Without using chemicals, the aim is to restore the soil to grow nutrient dense food with a positive environmental impact.

**Market garden:** It was very inspiring to hear the hard work, in the face of challenging weather conditions, that goes into growing a vast array of different organic veg. Chris, director of the market garden, explained about how the secret to tasty, nutritious vegetables is in the health of the soil. We all left with armfuls of veg we bought from the fridge at the farm.



"The secret is in the compost!"



Visit the farm fridge: Just put the money in the honesty box.



### Local, organic vegetables delivered to your door:

The market garden works with Hampshire Veg Box to provide a delivery or collection service. As much of the produce as possible is grown on the farm or locally. An electric van delivers to the Meon area on Thursdays, or you can collect from the farm.

### Volunteering and craft workshops

You can volunteer to help at the market garden on Wednesdays (9a.m.-3p.m.) but there are also other opportunities to volunteer through the week. Rushmere farm also runs craft workshops, such as spoon carving and bench making.

Find out more: [hampshiremarketgarden.co.uk](http://hampshiremarketgarden.co.uk)  
[rushmerefarm.com](http://rushmerefarm.com)

### Meon Valley Community Bus

Did you know you can hire the bus for your own private use?



CANS and SoberNewts hired the bus to take members on the visit to Hampshire Market Garden.

It could be a great option for a family party event or theatre trip, for example. However, as the bus relies on volunteer drivers, the hire would be dependent on a driver being available.

(See contact details for the MVCBA at the back of the magazine to find out more).

Did you know?



You can recycle hard plastic pots, tubs and trays at the following places:

### Portsmouth City Council Local Recycling Points:

[www.portsmouth.gov.uk/service-s/recycling-and-rubbish/local-recycling-points/](http://www.portsmouth.gov.uk/service-s/recycling-and-rubbish/local-recycling-points/)

Our nearest point is:  
**Havant Road,  
Farlington (in front  
of Tesco Express)  
PO6 1NF**



## Soberton & Newtown Local History Society



### UPCOMING TALKS

**Thursday 10<sup>th</sup> October 2pm**

**Anglo Saxon Detectives – Dr Lyndon Palmer**

Lyndon has spoken to us before and his enthusiasm for the Anglo Saxon period shines through at his talks. We are sure to find out something amazing!

**Thursday 14th November 2pm**

**The History of Portsmouth – Part 4. 1930 to the Present Day – Andrew Negus**

Andrew is always an entertaining and informative speaker, and this is the final part of his Portsmouth odyssey “Harlots, Dung and Glory” which brings us up to the present day. If the first three parts are any indication, this is one not to be missed!

Meetings at Rookesbury Hall, Church Road, Newtown 2 p.m.

History Society membership £12 per year

Visitors always welcome £2 per meeting

## **Soberton & Newtown Ladies Group**

We started the new programme in September with Martin Bazeley telling us all about the Southwick Revival from its origins to its success in 2024, and into the future. Also of interest was a National Farm Survey in 1941, intended to encourage increase in food production in WW11.

On Wednesday 2nd October at 8pm, Ellen Hawkins will be taking us through the art of decorating biscuits with the option of 'having a go'.

Venue is Rookesbury Hall, Newtown at 8pm as usual.

The meeting on 6th November is in St Peter's Church Room Soberton, at 8pm. Andy Rankine will be telling us about Air Traffic Control - The first Hundred Years and beyond.

New members are always very welcome.

Liz Whales (Secretary) 01489 877712      lizwhales@aol.com

## Road Report

Edited by Jonty Sherwill this feature aims to raise awareness about what we can each do to encourage more considerate driving with benefits for all road users whether on foot, horseback, cycle or behind the wheel or reins. The views expressed are personal and based on 50 years of driving. Friendly feedback is always welcome.

As the year moves on and with the prospect of frosty mornings and dark evenings, for those who do a daily commute a well maintained car is important for a safe and reliable journey but also is good visibility for you and other road users. A later than intended start with iced up windows, or dirty lights and number plates could be a recipe for mishap, when what matters more is getting there safely.

This reminded me of the Australian premier Bob Hawke speaking in the early hours of Tuesday 27th of September 1983, the day the 12-Metre class yacht 'Australia II' won the America's Cup, beating the USA for the first time in the 132 year history of the AC, an event still going strong right now. 'Any boss who sacks anyone for not turning up today is a bum!' is what Hawke said, and one hopes that the same would apply for being a few minutes late on a cold and frosty morning!

I don't imagine that Australians have to worry too much about icy roads, a greater hazard for them is more likely to be hitting a kangaroo, which I hope brings me neatly to my next topic, speeding and the impact on roadkill, both wild and domestic.

Opinions will vary on whether killing a few birds and squirrels etc. matters much to their populations but what does have more emotional impact is the death of a much-loved 'moggie' or the trauma of hitting a deer. Three times in the last month I have picked animals of the road and put them on the verge.

The likelihood of these incidents will be affected by speed and so will be the severity of damage to your car - and taking avoiding action is a whole lot different at 30-40mph rather than 50-60. 40mph is the speed limit on the New Forest roads, so why not the Forest of Bere also?

Okay, driving more slowly through the forest and built up areas might cost you a minute or two in journey time but the relaxing effect brought by knowing you are doing what you can to reduce risk to our hard-pressed wildlife more than compensates, at least it



does for me. Perhaps the worst feeling is needlessly killing someone's cat and the heartache that brings.

Of greater importance of course is consideration for pedestrians, cyclists, horse riders etc. All of this is a part of what might be described as 'roadcraft', something that I think would benefit from more attention nationally, as IAM Roadsmart has done for many years.

Perhaps my memory is rose-tinted but in decades past there seemed to be more mutual cooperation on the roads and less of the 'gotcha' attitude of modern driving. Fewer police patrol cars to keep an eye on things might be part of it. Having sailed all my life and under a strict set of racing rules, to work effectively these have to rely on 'self policing' to keep the sport fair. 'Room and opportunity' for another yacht to keep clear of yours is part of the mantra, and that same approach can, and in my view, should apply for driving.

See you next issue and if there are topics you'd like raised, then please let us know.

## Just one more year!



After much thought and family discussion I feel the time has come to pass on the role and step down as Brown Owl from July 2025. It does seem a long way away, but I felt it was best to give as much notice as possible as we do not currently have a Leader who is able to take on the main role. We are actively looking to find a replacement, and are hopeful that a new leader will be found before July 2025.

I have been the main Leader at the unit for the past 16 years and I will continue to be the main Leader for Soberton & Newtown Guides and will be continuing with my roles in the Division and County. So I will still be active in Guiding and the local units.

Would you be interested in becoming a Brownie Leader?

The role is open to any female over the age of 18, and if any of you are interested in finding out more, do have a chat with me or Tawny Owl. Anyone taking on a leader position would need to join Girlguiding, which entails a DBS check and references, with full training and support is given at many levels. Our Division Commissioner, Nikky is excellent and would be able to talk you through the process, and of course I am here to help, as well as the other unit leaders. Girlguiding have a set training programme for new leaders and a lot of the modules are done online, through the Guiding Training Platform.

The role itself is very rewarding. To be able to introduce new activities and adventures to the Brownies is always a joy, and there are so many different events available to join in with, as well finding new ones. However, I would not be honest if I said it was always fun, there are occasions when it is challenging, but the other Leaders in the Unit, the Division and the County are very supportive, and who doesn't enjoy a challenge?

...and when a Brownie gives you a smile and say 'that was fun, thank you', it is all worthwhile.

We will be continuing with our Brownie Programme throughout the year and will be offering many different events and opportunities to the girls during the next 12 months, and hopefully beyond.

With very best wishes,

*Caroline Rogers* aka Brown Owl

# Meet & Eat

Formerly known as the Ladies Lunch Club.

On the last Friday of each month we meet at The White Lion, Soberton for a fun lunch – a starter or main meal, the choice is yours - and welcome old and new villagers from Soberton and Newtown.

We began these lunches when Allan became landlord of The White Lion to support him and the pub – and clearly this has worked!

Fine food, lovely location, convivial company!

So, please contact Sue if you wish to go on the mailing list as we do need to know numbers attending.

No pressure- come when you can.

Email: [sue@poppyhill.net](mailto:sue@poppyhill.net)

# STUDIO 6

## DESIGN & PRINT

Business Cards & Letterheads • Leaflets & Flyers  
 Wedding Stationery • Funeral Orders of Service  
 Banners & Signage • Booklets & Brochures  
 Personal Stationery • Labels, Rubber Stamps & much more!

[www.studio-6.co.uk](http://www.studio-6.co.uk)

*We have new premises!*

PLEASE CONTACT US VIA PHONE OR E-MAIL

01329 832933 • [print@studio-6.co.uk](mailto:print@studio-6.co.uk)

## EXPERT TAX ADVICE WITH A HUMAN FACE FOR THE MEON VALLEY

### WATCHING OUT FOR THE NEXT GENERATION

Is IHT a factor in making my Will? Is a Family Trust a good idea?

### PROPERTY OR WORK OVERSEAS

How does it affect my tax if I live, work or have property abroad?

### FOR ENTREPRENEURS

Am I the only one wondering whether it's worth all the aggro?

### PERSONAL TAX

What is the best way to order my tax affairs, in full compliance with the law?

### SELLING MY BUSINESS

How much tax will I pay? What is my business worth?

*Nicholas Ridge*  
 TAX EXPERTISE

Oakleaf, Ludwells Lane, Waltham Chase, Southampton, SO32 2NP

t: 01489 899102 e: [nicholas@nicholasridgecta.co.uk](mailto:nicholas@nicholasridgecta.co.uk)

[www.nicholasridgecta.co.uk](http://www.nicholasridgecta.co.uk)

## CARPET & UPHOLSTERY CLEANING HIGH QUALITY & AFFORDABLE

- Independent Family Run & Owned Business - Est 2003
- Carpets, Leather, Rug & Curtain Cleaning
- Approved by Trading Standards
- Honest & Competitive Pricing
- Rapid Drying Times
- Discounts for Whole Houses

*'We have used Elliott Carpet Care for many years and have never ever been disappointed. Carpets and sofas come up like new. The attention to detail and care taken is extraordinary'.*

Call us today on:

**M: 07436 266078**

[www.elliottcarpetcare.co.uk](http://www.elliottcarpetcare.co.uk)



All aspects of Carpentry & Building work undertaken

- Extensions • Alterations • Refurbishments
- New Builds • Landscaping

Tel: 02392 632037 Mob: 07885 283036

[jay.tucker16@yahoo.co.uk](mailto:jay.tucker16@yahoo.co.uk)

Fully qualified and insured



### The Perfect Space for Meetings or Committees

HOST YOUR NEXT MEETING OR  
 PRESENTATION IN A DISCREET AND  
 PRIVATE AREA.

RURAL LOCATION NEAR HAMBLEDON.

- Seating area for 6 to 8 people.
- Parking up to 4 cars.
- Ultra Fast Internet.
- Coffee, tea, cold drinks facility.
- WC.

ENQUIRIES:

Contact Ben **07973668539**  
 by text or WhatsApp

Discount offered for repeat or regular bookings

## FOR ALL YOUR DRY CLEANING AND LAUNDRY NEEDS

Duvets Laundered  
 Curtain Cleaning & Alterations  
 Tailor Repairs & Alterations  
 Wedding Dresses Cleaned & Boxed  
 Specialist Rug Cleaning Service



Laundry Service  
 Carpet Cleaning Machine Hire  
 Waxed Garments Cleaned & Re-Waxed  
 Pillows Cleaned & Recovered  
 Suede & Leather Cleaning

4 Merlin Mews, Bishop's Waltham. Tel: 01489 894421 • Agent: Meonstoke Post Office

[www.bryantscleaners.co.uk](http://www.bryantscleaners.co.uk)

## MARK & JUNE MASON

Husband and wife high quality painters and decorators. Period to modern properties, one room to a whole building. We work around your requirements.

[www.masonspaint.co.uk](http://www.masonspaint.co.uk)

Phone 01329 235847

Mobile 07973 162397

52 The Causeway, Fareham PO16 8RW

## Ray Chandler STATION GARAGE FAREHAM LTD

SERVICING, MECHANICAL & BODY REPAIRS,  
WELDING, M.O.T. TESTING,  
BREAKDOWN SERVICE

Tel: **01329 238451**

[www.stationgaragefareham.co.uk](http://www.stationgaragefareham.co.uk)

Unit 1, The Avenue, Fareham, Hants PO14 1NP



All Types of Carpentry, Joinery & Building Work Undertaken  
Kitchens, Bathrooms, Windows & Doors (wood & U.P.V.C.)  
Renovations & Repairs, Wardrobes & Cupboards,  
Bespoke Joinery, Furniture Restoration, Painting & Decorating.

Professionally Qualified & Insured  
30+ Years of Local Experience

M: 07875 557961 T: 01489 895890

E: [leeacooper@talktalk.net](mailto:leeacooper@talktalk.net)

W: [www.leecoopercarpentry.co.uk](http://www.leecoopercarpentry.co.uk)

Sweeps of all types of appliances carried out  
Stove maintenance and repairs carried out  
Bird guards / Caps supplied and fitted  
CCTV inspections carried out  
Fully insured  
Certificates issued

Neil Jarrett 0751 0304 888

[neil@sunrisechimneysweeps.co.uk](mailto:neil@sunrisechimneysweeps.co.uk)  
[www.sunrisechimneysweeps.co.uk](http://www.sunrisechimneysweeps.co.uk)



# WELLER PATRICK

## SOBERTON AND MEON VALLEY PROPERTY EXPERTS

Experienced local team with  
detailed knowledge of the area.

**01489 893555**

[www.wellerpatrick.com](http://www.wellerpatrick.com)  
[info@wellerpatrick.co.uk](mailto:info@wellerpatrick.co.uk)



## THE WHITE LION

BED & BREAKFAST

BEER GARDEN,  
FUNCTIONS, HOME  
COOKING AND  
LOCAL BEERS

TELEPHONE: 01489 877346

[INFO@THEWHITELIONSOBERTON.CO.UK](mailto:INFO@THEWHITELIONSOBERTON.CO.UK)  
[WWW.THEWHITELIONSOBERTON.COM](http://WWW.THEWHITELIONSOBERTON.COM)



# Pressing Needs



## The Fabric Care Specialists

**FREE**

**Collection & Delivery**

Tuesday & Friday

**25% off Duvet Cleaning**

with Promo Code: S&N25

[www.pressingneeds.co.uk](http://www.pressingneeds.co.uk)

[verity@pressingneeds.co.uk](mailto:verity@pressingneeds.co.uk)

- Laundry
- Dry Cleaning
- Ironing
- Shirt Service
- Bedding Laundry
- Duvet Laundry
- Curtain Cleaning

Duncan Rd, Park Gate, Southampton, SO31 1BD

01489 582095

MEON VALLEY  
**Mowers**  
SERVICE AND REPAIRS

Specialist in professional & domestic  
mower & garden machinery

- Service & repairs
- Collection & delivery
- Competitive rates
- Rotary blades, cylinders & hedge cutter sharpening
- Visit our workshop



07783 937212 or 01489 878085

[info@meonvalleymowers.co.uk](mailto:info@meonvalleymowers.co.uk)



**H**  
**HAMBLEDON**  
**CARS**

PRIVATE TAXI SERVICE

Superior Air Conditioned Cars  
8 Seater Minibus  
Airports, Stations & Cruise Transfers  
Theatre, Shopping, Business  
& Local Travel

**Steve & Tracey Eames**

M: 07766 027 301

W: 02392 632 375

[hambledon-cars@hotmail.co.uk](mailto:hambledon-cars@hotmail.co.uk)  
[www.hambledoncars.co.uk](http://www.hambledoncars.co.uk)

West Street Hambleton Hampshire

**TP Mushroom Catering**

**Bringing Masterchef  
to the Meon Valley**

Masterchef contestant Gill Holland provides bespoke menus that give your special occasion the wow factor! Traditional British fare, a Thai feast or a Mediterranean mezze, canapés at a drinks party to full wedding packages.

Whatever your event give Gill a call on the contact details below:

[www.mushroom-club.co.uk](http://www.mushroom-club.co.uk)

**West Down Cottage, Chalk Hill,  
Soberton, SO32 3PH**

**07879 696495, 01489 876741**

# MJM

## Plumbing & Heating

36 years experience in the plumbing & heating industry

- Natural gas, L.P.G and oil boilers installed
- Oil tanks installed & maintained
- Power flushing
- Full bathroom installations including wall & floor tiling
- Unvented hot water systems installed, serviced and maintained
- Grant Oil Boiler Approved Installer

NO  
CALL OUT  
CHARGE

**NOW OFFERING 0% finance on all  
Vaillant boilers and products!** Call for details

Tel: **01329 507712** Mob: **07773 385946**  
info@mjmplumbing.co.uk www.mjmplumbing.co.uk



Based in Wickham

### TJ

## CHIMNEY SWEEPS

TEL: 02392 002872

MOB: 07950 145494

COMPETENT, CLEAN & RELIABLE

[WWW.TJCHIMNEYSWEEPS.CO.UK](http://WWW.TJCHIMNEYSWEEPS.CO.UK)

FULLY INSURED & REGISTERED WITH THE INSTITUTE OF  
CHIMNEY SWEEPS.

SEE US ON CHECKATRADE.COM

## Robert Crook Garden Maintenance

All general gardening work undertaken

Tel: 02392 258686

Mobile: 07929 092299



ANNIE CARTER  
MOBILE MASSAGE THERAPIST  
&  
WELLNESS CONSULTANT

# 07791842953

WHATSAPP/MESSAGE

All seasons general garden maintenance

Mob: 07763 494006 Tel: 01489 878 598

tudorgardener@gmail.com

@Tudorgardener

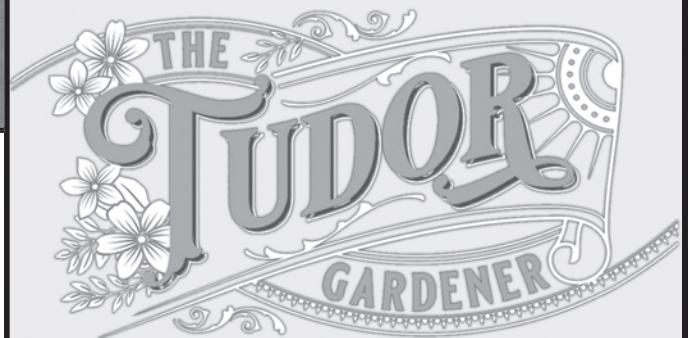

Specialising in:

- Hedge cutting & shrub shaping
- Garden design
- Fruit tree and rose pruning

RHS TRAINED

# SYCAMORE TREE SURGEONS

All aspects of tree work

**Pruning Surgery Felling Hedgecutting  
Tree Stump Removal and Site Clearance  
Approved contractors for local authorities**

**FULLY INSURED**

**023 9223 0146**

**Mob: 07889 704449 David Farrington**  
**30 YEARS EXPERIENCE**



J. Gordon

Forestry & Arboriculture Ltd

- Crown Reduction/Re-shaping • Thinning/Dead Wooding • Skilled Tree Removal • Hedges
- Plantation Maintenance • Tree Planting • Fencing • Woodland Management • Stump Grinding

**Professional Qualifications • Insured in all aspects of forestry and tree surgery**

For a personal and caring service contact Joe Gordon

**24 HOUR EMERGENCY CALL-OUT • FREE QUOTATIONS**

**Hambledon 023 9263 2418 Mobile 07712 808 081 www.treedocjoe.co.uk**



**Taylor's Garage**  
**Droxford**  
Hampshire SO32 3QL



**Tel: 01489 877433**

## CAR and MOTORCYCLE MOTs

Service and repair to cars  
light commercials and horse trailers

Air conditioning - service & repair

Competitive prices on  
tyres batteries and exhausts

Collection & delivery or loan car available  
subject to availability

**BUY WITH CONFIDENCE**  
Trading Standards Approved Trader

Sweeps of all types of appliances carried out  
Stove maintenance and repairs carried out  
Bird guards / Caps supplied and fitted  
CCTV inspections carried out  
Fully insured  
Certificates issued

Neil Jarrett 0751 0304 888  
info@sunrisechimneysweeps.co.uk  
www.sunrisechimneysweeps.co.uk



CORE STRENGTH  
FLEXIBILITY  
FLAT STOMACH  
JOINT MOBILITY  
REDUCED STRESS  
TONING  
IMPROVED POSTURE

## PILATES

## PILATES

CARRIE MANDLEY RGN  
PILATES INSTRUCTOR  
PHONE 07854 413352



**SOLENT**  
DESIGN

- Design
- Artwork
- Stationery
- Leaflets
- Flyers
- Brochures
- Booklets
- Newsletters
- Labels
- Postcards
- Folders
- Posters
- Banners
- Vinyl
- Exhibition Displays



**Tel: 01489 892344 • Email: sales@solentdesignstudio.com**  
**www.solentdesignstudio.com**

Andrew Smyth

**HANDYMAN & DECORATING SERVICES**

BASED IN  
**Newtown**

*General Home Maintenance  
Painting & Decorating  
Carpentry & Fencing  
Bespoke Wooden Goods  
Plumbing & Electrical  
Domestic & Commercial  
AND MUCH MORE!*

Feel free to contact me!  
07909253681  
andrew.j.smyth65@gmail.com

 andrew\_the\_handyman  AndrewSmythHandyman

**Wickham Fisheries**

**Your local Take Away  
A wide variety of food**

**Gluten-free chips available everyday  
Gluten free menu for other products  
available every day (call and place your  
order half an hour before collection)**

**Find all opening information and our menu  
on Facebook – Wickham Fisheries**

**The Square  
Wickham  
PO17 5JQ  
Tel 01329 832394**



**Local & Award Winning  
Luxury Self-Catering**

- Ideal for family gatherings, celebrate here!
- Indoor heated pool and jacuzzi with hoist, sauna & steam room
- Hot tubs, en-suite bedrooms, wood burners
- Dog friendly, enclosed gardens, accessible
- Country views, EV charging points, free WiFi

**WALLOPS WOOD COTTAGES**  
wallopswoodcottages.co.uk

**GRENVILLE AT WALLOPS WOOD**  
grenvilleatwallopswood.co.uk

**01489 878888**

**unwind@wallopswoodcottages.co.uk**

**Book with confidence and unwind with us**

**RICHARD  
STEEL  
& PARTNERS**

**THE FAMILY OWNED  
FUNERAL DIRECTORS**



[www.steelsfuneral.co.uk](http://www.steelsfuneral.co.uk)

**BISHOP'S WALTHAM**  
The Gate House, Victoria Road,  
Bishop's Waltham, SO32 1DJ  
01489 892640

**WINCHESTER**  
Alderman House, 12-14 City Road,  
Winchester, SO23 8SD  
01962 862333

Available 24 Hours

## B.G. Property Maintenance

EST 1974

Internal and External Painting &  
Decorating

Roof Repairs – Gutter Maintenance

Pointing – Brickwork & Plastering  
Repairs

Glazing – Tiling – Paving – Carpentry

CLINT: 07836 620844

BOB: 07971 551513

Email: [rgoble717@btinternet.com](mailto:rgoble717@btinternet.com)

FULLY INSURED  
FREE QUOTES

# BOWMAN

ALES LTD.

TRY OUR AWARD WINNING ALES



Our beers are available in bottles, bags-in-boxes or casks, all direct from the brewery

01489 878 110

[info@bowman-ales.com](mailto:info@bowman-ales.com) [www.bowman-ales.com](http://www.bowman-ales.com)



Household and Business storage

# 02392 384 888

## BARN-STORE.CO.UK

Offwell Farm, Southwick, Fareham, PO17 6DX

# Hurricane Farm



### Our Services:

- Mobile educational farm
- Incubator hire
- Breeders of pedigree Tamworth and Gloucestershire old spots
- Breeder of rare breed poultry and garden hens
- Supplier of quality pork

01489 878218 - 07876244146

## LOCAL FARRIER

(Soberton Based)

## David Povey Dip WCF

For:

Hot & Cold Shoeing  
Remedial Shoeing

Established 1985

**01489 878218**



Part P Full Scope  
**Electrician**

Derek Pilcher JIB Approved

*Domestic • Commercial • Industrial  
Agricultural • Rewires • Extra Sockets • Lights  
Showers • Cookers • Fuseboards  
Security Lights etc*

**Testing and Certification  
Emergency Call-Out available**

Tel: 02380 602 627 Mob: 07766 418 039  
Email: derekpilcher36@yahoo.co.uk

## **CHAMBERLAINS**

Family Solicitors

We can help you with a wide range of legal services including Residential Conveyancing, Commercial Property, Probate, Wills and Lasting Powers of Attorney

RED LION STREET (OFF HIGH STREET), BISHOPS WALTHAM

**TEL: 01489 896141**

info@chamberlainslaw.co.uk

## **KS Groundworks**

Local General Builders & Ground Maintenance, Hardscaping, Drives, Slabs, etc.

Over 30 years experience.

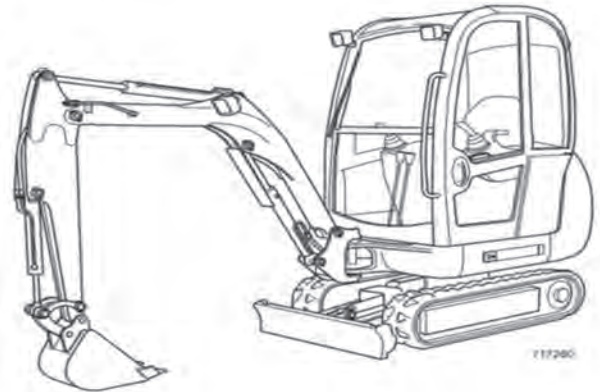

**Tel: 07801 141517 Email: kym.slater@gmail.com**



## **South Downs Funeral Service** Funeral Directors & Memorial Consultants



Your Local, Independent & Family Owned Funeral Homes of Denmead, Wickham & Clanfield

**Our Clanfield Funeral Home**

43 Drift Road, Clanfield PO8 0JS

**Tel: 02392 570239**

clanfield@southdownsfuneralservice.com

**Our Denmead Funeral Home**

The Old Post Office House, Hambledon Road,

Denmead PO7 6NN | **Tel: 02392 231567**

care@southdownsfuneralservice.com

**Our Wickham Funeral Home**

13 The Square, Wickham,

Fareham, PO17 5JG | **Tel: 01329 833920**

wickham@southdownsfuneralservice.com

**Direct Funeral Services from £995.00**

**Traditional & Tailored Funeral Services from £1725.00**

www.southdownsfuneralservice.com

**Golden Charter**   
Smart Planning for Later Life

Golden Charter Funeral Plans  
24 hour, local and personal service  
Floristry service | Stonemasonry service  
No deposits required  
Fully accredited and regulated members of SAIF





# PIMP MY Paddock

Paddock Maintenance

We offer a complete & professional paddock maintenance service

Located near Bishops Waltham, covering all surrounding areas.

Paddock, field & garden work is carried out using a quad bike, ensuring easy access to small & large areas with no heavy tyre marks.

- Paddock Maintenance
- Topping
- Fertilising
- Spraying
- Springtyning
- Harrowing
- Hedge Cutting
- Fencing & Gate Repairs
- Log Splitting & Chipping
- Full Public Liability Insurance

**Phil Stratten 07799 118 022**

mail@pimpmypaddock.com

www.pimpmypaddock.com



## APARTMENTS FOR HIRE



### Luxury One bedroom

We are offering this luxury apartments in Gosport. Fully furnished and equipped. High speed Internet.

**ALL BILLS ARE INCLUDED**

**NO DEPOSIT, NO FIXED CONTRACT, NO MINIMUM OR MAXIMUM STAY.**

#### IDEAL FOR:

- Accommodation for business contracts.
- Insurance placement.
- Long term guests.
- While house works are on going on.
- Change of personal circumstances.
- In between house moves.



For more information of pricing

**CONTACT: Ben 07973668539**

# StorAway

Your local choice for storage



Secure Storage for Classic Cars, Archived Documents and Personal Property. Long or short term storage options available.

**For ALL your storage needs  
Contact StorAway on 01489 877988  
or www.storaway.co.uk**

## G. RIXON LTD.

ELECTRICAL PLUMBING AND HEATING ENGINEERS



**01329 834600**

enquiries@g-rixon-ltd.co.uk

www.g-rixon-ltd.co.uk

We carry out small jobs such as attending to faulty light fittings and dripping taps, to larger jobs such as complete rewires and replacement bathrooms. We are disabled adaptation specialists and install level access showers and accessible kitchens.

G. RIXON LTD. Wynot Heath Road Soberton Hampshire SO32 3PQ

## R & G GAMBLIN

Extension Alteration Renovation

Planning work

- Bricklaying.
- Civil Engineering.
- UPVC Windows & Doors.
- Plastic Fascia & Soffit.
- Concrete.
- Loft Conversion.
- Roofing Pitch & Flat.
- Painting.
- Conservatories.

- Digger Hire.
- Drainage.
- Fencing.
- Plastering.
- Driveways.
- Plumbing.
- Garages.
- Carpentry.
- Electrics.

For Free Estimates please phone  
Rob 01489 - 891801



# SAFER CHIMNEYS

Member of National Association of Chimney Sweeps  
NACS Certificates Issued.

“Highly Recommended” Local Chimney Sweep

Power Sweeping, Traditional Brushes,  
Chimney Camera Surveys  
Stoves, Open fires, Range Cookers

Less waiting time – 2 qualified sweeps

023 9247 6458 or 07733 343530

or 07847 466281

david@saferchimneys.co.uk

Proud members of  
**Checkatrade.com**  
Where reputation matters

[www.saferchimneys.co.uk](http://www.saferchimneys.co.uk)

## TREE SERVICES

RESIDENTIAL & COMMERCIAL  
HAMPSHIRE & SURROUNDING AREA

FOR MORE INFORMATION  
[www.wgstreeservices.co.uk](http://www.wgstreeservices.co.uk)

info@wgstreeservices.co.uk

or

CALL 07810 044 420



## BULK BAGS

HARDWOOD | SOFTWOOD | KINDLING  
FREE LOCAL DELIVERY

CALL 07810 044420  
or

ORDER SECURELY ONLINE  
[www.wgskindling.co.uk](http://www.wgskindling.co.uk)

FOLLOW US



## A Beautiful Yoga Studio in Wickham

A real hidden gem in Hundred acres.  
Providing a range of yoga classes for all abilities  
in a beautiful and tranquil environment.  
Ample free parking.

Visit [birchtreeyoga.co.uk](http://birchtreeyoga.co.uk) or call Karen on **01329 834511**



**ICAEW**  
CHARTERED  
ACCOUNTANTS

Chartered Accountants  
& Registered Auditors

LOCAL INDEPENDENT ACCOUNTANTS AND  
TAXATION ADVISORS

**FREE INITIAL CONSULTATION**

Full range of accountancy, auditing and taxation services

Business start up advice

Book-keeping and Payroll Services

Self-Assessment Returns

Detailed Fixed Cost Quotes

Visits to your Premises

Avalon House, Waltham Business Park,  
Brickyard Road, Swanmore, Southampton,  
SO32 2SA

Tel: 01489 896996 Fax: 01489 895255

Email: [enquiries@butlerco-bw.co.uk](mailto:enquiries@butlerco-bw.co.uk)

Website: [www.butlerco-bw.co.uk](http://www.butlerco-bw.co.uk)



## Tudor

PEST CONTROL

Mandy Haggart BSc.  
07307 167 244

info@tudorpestcontrol.co.uk  
[www.tudorpestcontrol.co.uk](http://www.tudorpestcontrol.co.uk)



**Contact Us Now!**  
Tel: 01489 896 903

Easy Clean Services

**CESSPIT / SEPTIC TANK EMPTYING**

**TANK EMPTYING**

- Cesspits
- Septic Tanks
- Interceptors
- Grease Traps
- Treatment plants
- Pump Stations

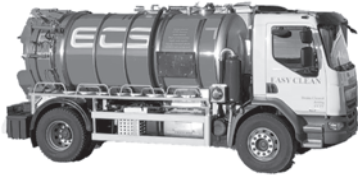

**SERVICING**

- All Treatment Plants
- Pump Sets
- Pumping Stations
- Water Pumps

**PUMP and PARTS**

- Air Blowers - All Makes
- Submersible pumps
- Spares and accessories
- Shop online or collect

**DRAINAGE SERVICES**

- Root Cutting
- CCTV Surveys
- Blocked Drains (Jetting/Rodding)

[info@easycleanservices.co.uk](mailto:info@easycleanservices.co.uk)  
[www.easycleanservices.co.uk](http://www.easycleanservices.co.uk)



SALES & REPAIRS

Wheely Down Garages  
Warnford, Nr. Southampton  
Hampshire SO32 3LG

Telephone/Fax: 01730 829207

[www.dj-scott.com](http://www.dj-scott.com)

We're the Which?  
**Insurance Brand of the Year**  
for the second year running

Whether it's for your car, home, farm or business, for quality insurance you can rely on, join us today.

Contact NFU Mutual Winchester, Alton and Wickham on **01962 881 888**



The National Farmers Union Mutual Insurance Society Limited (No. 111982).



GEMMA WILLIAMS  
PRIVATE TRAVEL



Gemma Williams Private Travel offers a truly personalised service creating unforgettable tailor-made trips around the globe. With over 15 years' experience within the travel industry at some of the UK's leading tour operators. I'll make your travel planning and trip hassle free with a personalised and professional service.

Beach Holidays, Safaris, Adventure, Family Holidays, Cruises, Private Villas, Honeymoons, City Breaks, UK Staycations and much more.

As a Soberton resident I am happy to meet you in your home, at a time convenient to you.

**GEMMA WILLIAMS  
PRIVATE TRAVEL**

WhatsApp / Tel: 07968 634556

[www.gwprivatetravel.com](http://www.gwprivatetravel.com)

[Gemma@360privatetravel.com](mailto:Gemma@360privatetravel.com)

All Holidays are ATOL Protected



To advertise please contact:  
**Kate Buttriss**  
[kate.buttriss@gmail.com](mailto:kate.buttriss@gmail.com)  
**07801 441998**

# DROXFORD ANTIQUES

The Old Bakery, High Street, Droxford SO32 3PA  
01489 878800 mark@droxfordantiques.co.uk

Established for over 40 years.

Still buying and selling antiques of all descriptions, valuations and probate service.

We repair, restore and polish in our own workshops.

## CURTAIN MAKING & ALTERATIONS

Stockists of Kate Forman, Vanessa Arbuthnott, Ada & Ina

We offer a full service from measuring to making beautiful hand sewn curtains, blinds and pelmets especially for you.

**Please telephone Mark or Mary for free, professional and confidential help and advice.**



## THE JOINERS SHOP

Period Joinery of Every Description

Conservation Approved  
Double Glazed  
Box Sash Windows

(Genuine) Handmade Kitchens

Tel: 02392 814780  
enquiries@thejoinershop.co.uk  
www.thejoinershop.co.uk



Associate Member of the Hampshire  
Buildings Preservation Trust Ltd

Associated Trades



LANDMARK  
DESIGN

**Meon Valley Studio**  
Design, Planning, Architecture  
& Land Management

landmark-design.co.uk +44 (0) 1489 899 033  
f /lmdarchitectural @lmd\_architecture

## WHITE ROSE PLUMBING Russell Beaumont

Free quotation  
No call out charge  
No job too small  
Family run local business  
24 hour emergency service

Tel: **01489 893419** Mobile: **07843 586366**  
Email: whiteroseplumb@googlemail.com

## FAREHAM Creek VETS

**32 East Street, Fareham PO16 0BY**  
**www.farehamcreekvets.co.uk**  
**Tel: 01329 280412**

Local, independent small animal practice  
Friendly, dedicated care for you and your pet  
See the same vet at each visit  
Close to Fareham town centre • Parking on site  
24 Hours Emergency Service

**M & S LOCKE & SON LTD**  
**PLASTERING & CERAMIC TILING CONTRACTORS**

Specialising in:

- All aspects of plastering
- All aspects of tiling  
*(inc. porcelain & stone interior/exterior)*
- Full bathroom refurbishments

Family run business with over 30 years experience, we offer a reliable, friendly, and quality service.

**For a free quotation/advice please call Dean on  
 Mobile: 07712 894119/Home: 01489 877199**



**HAMBLEDON GARDEN  
 MACHINERY**

All aspects of garden machinery repairs and servicing, including small plant & agricultural tractors  
**Delivery and collection available**

Get in touch  
 07788 907334



**C R A M E R B E S P O K E**

C A B I N E T R Y | K I T C H E N S | F U R N I T U R E

T: 02392 632222 M: 07805 040464  
 josh@cramerbespoke.com

*Why not read our glowing reviews from some of the Meon Valley's most fabulous residents ?*

[www.cramerbespoke.com](http://www.cramerbespoke.com)



**Oliver Chimney Sweep**



Experienced member of the Guild of Master Sweepers.

Insurance approved certificates issued with every sweep.

Professional, clean brush and vac system.

02392 787967

Email: [info@oliver-chimney-sweeps.co.uk](mailto:info@oliver-chimney-sweeps.co.uk)



**CARTERS**

GARDEN MACHINERY  
 SINCE 1921

Celebrating 100 Years



**Machinery Sales | Service | Repairs | Hire**

- Robotic Mower Installers
- Free Site Surveys & Advice
- Battery Machine Specialists
- Lawnmowers & Ride-Ons
- Hedge & Brush Cutters
- Chainsaws & Safety Clothing
- Leaf & Litter Blow-Vacs



**Call us on: 01489 575242**  
**Visit Our Store or Buy Online**

[www.cartersgardenmachinery.com](http://www.cartersgardenmachinery.com)

Duncan Road, Swanwick, Southampton, SO31 1BD. (Opposite Swanwick Railway Station. Follow the signs to the station from Park Gate.)



see me at [www.trustatrader.com](http://www.trustatrader.com)



**Mark Oliver**  
PLUMBING & HEATING



**INDEPENDENT FAMILY BUSINESS - ESTABLISHED 2002**

**All Domestic Plumbing Undertaken**

Fully insured & Qualified Plumbers covering Hampshire area

Solar Hot Water & Air Source Heat Pump Installer

Oil Boiler Heating Specialist

Oil Boiler Installation & Servicing

Approved Grant Boiler Installer

12 Month Guarantee on all Installations

Finance Available - Senior Citizen Discounts  
Card Payments Accepted

**07743 386 540**

**01489 876 556 - 01962 435 026**

[www.moliverplumbing.co.uk](http://www.moliverplumbing.co.uk)

email:[moliverplumbing34@gmail.com](mailto:moliverplumbing34@gmail.com)



GATES HOUSE GARDENS

**Bespoke, hand crafted and tailor made just for you**

- Extensions
- Summer houses
- Gazebos
- Garages
- Offices
- Decking
- Patios
- Driveways
- Woven steel - fencing, screens, planters
- Design ideas and solutions



[www.gateshousegardens.com](http://www.gateshousegardens.com)  
**07885 663 829** or email  
[jon@gateshousegardens.com](mailto:jon@gateshousegardens.com)  
Soberton Heath, Hampshire

**REQUEST A QUOTE TODAY**



**LANDSCAPE & GROUND WORKS Ltd**

Free Estimates - Quality Work - Competitive Prices

**Brick Laying • Block Paving • Patios  
Concreting • Drainage • Extensions  
Garages • Decking • Fencing • Turfing**

All other aspects of Hard and Soft Landscaping and Maintenance

KEVIN HALL **07808 496004**

Tel: **01329 832169** Email: [lbhkevinhall@gmail.com](mailto:lbhkevinhall@gmail.com)



**WINDOW CLEANING**

**OUR SERVICES**

- Fascias, Soffits & Gutters
- Gutter Clearances
- Conservatory Roofs
- Roof Cleaning / Moss Removal
- Patio Cleaning



Find us on [@dmwindowcleaninghamshire](https://www.facebook.com/dmwindowcleaninghamshire)

**07815 698 140**  
[www.dmwindowcleaning.com](http://www.dmwindowcleaning.com)

**Mrs G's Pilates**



- Enhanced core strength
- Improved flexibility
- Greater postural control
- Freedom of movement
- Self awareness
- Sense of well being

Tuesday Rooksbury Hall 9.15-10.15am, Wednesday The Meon Hall 9.15-10.15am, Rooksbury Hall 6.30-7.30pm, Thursday Denmead 9.15-10.15am, Rooksbury Hall 6.30pm-7.30pm. Friday Droxford Hall 9.15-10.15 am & 10.30-1130am

Contact Charlotte Graetz: 07776221077 or [charlotte@mrsgpsilates.co.uk](mailto:charlotte@mrsgpsilates.co.uk)

# North ProBuild Ltd.

**General building, Extensions,  
Refurbishments, Kitchens,  
Bathrooms, Landscaping,  
Driveways, Patios and Decking.**

**Portfolio & References available,  
helpful friendly reliable advice.**

**Local Family run business in Soberton.**

Please contact Darren

- ◆ darrennorth75@gmail.com
- ◆ 07946 106431
- ◆ 01329 833997



dwelldesign  
Ltd

## A RIBA CHARTERED PRACTICE



Listed buildings



Bespoke residences



Conversions

"Anthony is a fantastic architect, who is passionate about what he does!"



PASSIONATE ABOUT SUSTAINABLE LIVING

01329 717515 | enquiries@dwelldesign.co.uk

Probate & estate planning - leading the way in providing an AFFORDABLE service

## WESTMINSTER LAW

Wills ~ Estate Planning ~ Probate



If you are over 60 it will cost you only  
**£95\*** for us to prepare your Will.  
We are also Lasting Power of Attorney  
specialists - only **£95\*** each LPA if  
instructed during the Will appointment.  
*Our prices include VAT, home visits\*,  
and Inheritance Tax advice.*

Call us now for a no obligation chat on  
**02392 706980**

[www.westminster-law.co.uk](http://www.westminster-law.co.uk) email: [info@westminster-law.co.uk](mailto:info@westminster-law.co.uk)

Westminster Law Ltd, 10 Grassmere Way, Waterlooville PO7 8QD

\*These very special rates are only available if you are over 60 years old. Minimum spend for a free home visit is £95.  
Our normal price for a standard single Will is £150, or £250 for a couple.

## Animal Assisted Learning & Private Tutoring Service

### What is it?

A unique, private tutoring programme that intergrates social and emotional learning with academic, allowing children to learn in a natural, outdoor environment through play and experience learning with their entire body.

### How does it work?

Children interact with animals from the ground whilst using obstacles and games to support learning key reading skills; phonemic awareness, decoding, fluency, vocabulary & comprehension.

### Why Animals?

Interacting with animals, particularly horses, supports the natural development of self motivation, confidence & problem solving. Including animals in tutoring enables the learning to be a full body experience & is a powerful way to achieve educational goals.

### Why Me?

- Individualised learning programmes available.
- Qualified, experienced & enthusiastic Primary Teacher.
- Qualified in Equine Facilitated Learning & Emotional Coaching.
- Sessions from £30

 07706420646

 HannahHurst.EFL@gmail.com

 Hannah Hurst - Helping Hooves

 HH\_HelpingHooves



# LOGS

Locally sourced, barn stored, seasoned hardwood logs

Delivered locally for free in bulk bags or loose loads.

*Charges may apply for long distance deliveries*

For enquiries contact Charlie

Email: [hambledonlogs@gmail.com](mailto:hambledonlogs@gmail.com)

Tel: 07788907334

The Boat Bosun provides high quality, shipwright, marine engineering, painting, and coating services to traditional and modern boat owners of wooden and GRP, yachts and powerboats.

[david@theboatbosun.com](mailto:david@theboatbosun.com)

07971 288064



## Computer Problems Solved

A qualified & experienced Computer Engineer who can efficiently solve your home and business computer needs.

*For a friendly, no obligation quote call:*

Chris Guénier: 01489 890738 or 07962 641796

 CPS Ltd

<http://www.cps-ltd.org.uk>

[info@computerproblemsolvedltd.co.uk](mailto:info@computerproblemsolvedltd.co.uk)



# What's on (Village Diary)

Month	Date/day	Event / group	Time	Details
October	1 <sup>st</sup>	Stitch & Chatter	14:00	Page 51
	1 <sup>st</sup> and 15 <sup>th</sup>	u3a	14:00	Page 35
	2 <sup>nd</sup>	MVCBA Annual Public Meeting	19:00	Page 50
	2 <sup>nd</sup>	Soberton & Newtown Ladies Group	20:00	Page 15
	5 <sup>th</sup>	Meon Valley Garden Club Autumn Plant Sale	10:00	Page 38
	6 <sup>th</sup>	Harvest Festival, Holy Trinity	10:00	Page 8
	8 <sup>th</sup>	Wickham Society	19:30	Page 46
	9 <sup>th</sup> and 23 <sup>rd</sup>	Pop in for coffee and cake at St Peter's	10:00	Page 49
	10 <sup>th</sup>	Soberton & Newtown Local History Society	14:00	Page 15
	12 <sup>th</sup>	Murder at the Village Hall, Rookesbury Hall	19:00	Page 13
	21 <sup>st</sup>	Central Meon Valley Councillors Surgery	11:00	Page 47
	25 <sup>th</sup>	Meet&Eat	Lunch	Page 17
	November	2 <sup>nd</sup>	Close date for PiNS Parish Christmas Card	-
5 <sup>th</sup>		Stitch & Chatter	14:00	Page 51
5 <sup>th</sup> and 19 <sup>th</sup>		u3a	14:00	Page 35
6 <sup>th</sup>		Soberton & Newtown Ladies Group	20:00	Page 15
10 <sup>th</sup>		RBL Service of Remembrance	10:50	Page 39
11 <sup>th</sup>		COPY DATE FOR DECEMBER / JANUARY	-	
12 <sup>th</sup>		Wickham Society	19:30	Page 46
13 <sup>th</sup> and 27 <sup>th</sup>		Pop in for coffee and cake at St Peter's	10:00	Page 49
14 <sup>th</sup>		Soberton & Newtown Local History Society	14:00	Page 15
16 <sup>th</sup>		Ploughman's Lunch Christmas Fair	12:00	Page 8
16 <sup>th</sup>		Droxford Christmas Market	10:00	Page 46
23 <sup>rd</sup> / 24 <sup>th</sup>		Botley Choral Society	19:30	Page 46
24 <sup>th</sup>		Stir-up Sunday, Holy Trinity	10:00	Page 4
28 <sup>th</sup> - 30 <sup>th</sup>		Soberton Players - Treasure Island	19:30/14:30	Page 7
29 <sup>th</sup>		Meet&Eat	Lunch	Page 17
Regular meetings/ events	1 <sup>st</sup> Tuesday	Stitch & Chatter	14:00	Page 51
	1 <sup>st</sup> Wednesday	Soberton & Newtown Ladies' Group	20:00	Page 15
	2 <sup>nd</sup> /4 <sup>th</sup> Weds	Pop in for coffee and cake at St Peter's	10:00	Page 49
	3 <sup>rd</sup> Monday	Meon Valley Investment Club	19:30	Page 51
	2 <sup>nd</sup> Thursday	Soberton & Newtown Local History Society	19:30	Page 15
	1 <sup>st</sup> /3 <sup>rd</sup> Tuesday	Meon Valley u3a	14:00	Page 35
	Last Friday	Meet&Eat	Lunch!	Page 17

## Children's Week 2024 – duck racing on the River Meon (only the NQT's got wet!)



## GIVE WAY TOGETHER!

Newtown resident Commander Charles Wylie OBE RN, a Korean War veteran who served for 40 years in the Royal Navy, joined a team of RN sailors to row across Portsmouth Harbour on 12<sup>th</sup> August, the day after celebrating his 91<sup>st</sup> birthday. He was accompanied by Lieutenant Commanders Hugo Mitchell-Heggs and Nic Hall, both seasoned Atlantic Ocean rowers. The trio embarked on *Captain Jim*, the boat used by Royal Navy Team *HMS Oardacious* which helps promote mental health awareness and raise money for charity.



Despite not having rowed - called pulling in the Royal Navy - for 70 years, Charles quickly found his rhythm. Reflecting on the experience, he said, "it just came back naturally" and that rowing again "made me feel 31 not 91." He added: "I miss the sea, so I was in my element out there."

This isn't Charles' first daring exploit; he completed a parachute jump with the Army's Red Devils last year, raising more than £23,000 for Alzheimer's Research UK. His wife, Jean, has been battling dementia for the past decade, and Charles is determined to continue fundraising, with plans to abseil down Portsmouth's Spinnaker Tower next year. Watch this space!

To contribute to this worthy cause, please visit <https://www.justgiving.com/page/charles-wylie-1678789500363> or use the QR code.

## BRAVO ZULU\* Charles!

\* Naval signalese for 'manoeuvre well executed'



Hello again,

The lecture programme for the MVU3A season is now in full swing.

So, on 1/10 John Landaw will lecture on **The Rotary Movement**. Some of you will know what Rotary is, many will not even if you have heard of it. My friend John is always an amusing and entertaining speaker. Come along and find out.

On 15/10 Penny Copeland talks on **Tudor and Stuart houses**. Penny has spoken to us before and is always a mine of knowledge and interest.

We continue on 5/11 with Geoff Watts talking on **Southampton vaults**. We have heard Geoff before and know he is an accomplished speaker amazingly able to provide dates and names from memory and without notes!

On 19/11 Mike Hollis will talk on **How Belgium won the First World War**. Mike is an authority on Egyptology but can offer many other subjects, and this is one.

Everybody is welcome. Guests will get an especially warm welcome. (Guests pay £2 to defray speaker costs.) Tea and biscuits are provided after the talk, and we always have pre-loved books for charitable sale.

Lyndon (programme organiser)  
Contact 07881991763 or [lyndonplmr@gmail.com](mailto:lyndonplmr@gmail.com)

Web site [u3asites.org.uk/meon-valley](http://u3asites.org.uk/meon-valley)

**u3a**  
learn, laugh, live



# A SNUG UPDATE

## Highlights

- ▼ Boutique opened for 12 months to support our Ukrainian guests with clothing and toiletries
- ▼ Lessons for adults
- ▼ Christmas celebrations with Santa
- ▼ Contributions to children's fun activity days and trips to shows and English pantomimes
- ▼ Donated and refurbished bicycles and all associated equipment provided to help with transport to work and school
- ▼ Household items for guests trying to set up a new home
- ▼ School trips and uniform
- ▼ Contribution to dentistry
- ▼ New baby support
- ▼ Vehicle maintenance
- ▼ Separate to SNUG, set-up and coordinated by Anna Easton and Beccy Ward, quiz nights and other fund raising activities to raise money for specific projects to support housing, transport and employment.

## ♥ The SNUG Future

The original SNUG operation, to support Ukrainians living locally, ceased fund-raising 12 months ago and will soon have distributed all the cash it raised.

SNUG lives on, however, with a new team, led by Sam, dedicated to fund-raising for both local Ukrainians and for Ukraine Relief - which takes items directly to Ukraine and particularly to orphanages.

Anna has stepped down from her committee role with SNUG as she has many family commitments and wants to spend more time with all her lovely grandchildren. Philomena remains on the committee at the moment to oversee administration of the original SNUG funds and the transition to the new organisation. Rachel will continue to support with any financial records and audits.

So as SNUG continues and evolves we are looking for new committee members. Please contact Sam, 07720 305613, if you are interested.

## ♥ Bags of Love Project

Ukraine Relief have set up a project similar to the shoe box appeal. The difference here is that the scheme runs all the time and is for children or adults. Please contact Sam 07720 305613 for more information, or to organise bag collection.

## ♥ Thank You

Big thanks to everyone who has generously donated items, Soberton Parish Council for the ongoing use of the pavilion and the Meon Valley Lions for use of their minibus. A special thanks, also, to Harry Kemp for his ongoing support of SNUG and helping with the donation deliveries to Ukraine Relief. We appreciate everyone who has supported SNUG in any way and hope you will continue for as long as is needed.

## ♥ SNUG History

As many of you may recall, SNUG, The Soberton & Newtown Ukraine Group, was created by a number of locals who wanted to support vulnerable Ukrainian refugees as they arrived in our local area. Sam Dunlop and Anna Easton were the co-founders, and with Philomena Bergin set up the SNUG committee. They were joined by Rachel Cole who took on the role of finance and auditing.

There were soon a number of charity events in place and £14,500 raised from our generous villagers, businesses, organisations and friends.

At the same time, many people were donating clothing and toiletries and so the SNUG Boutique was also launched by Sam Dunlop.

In addition to the committee, a network of wonderful volunteers also became involved in all aspects of raising funds and supporting our guests.



## Ukraine Relief

### Items currently required:

- ▼ FOOD: non-perishable - canned or dried foods, instant snacks and meals, special dietary (gluten free etc.)
- ▼ SANITARY/ HYGIENE: toothbrushes, toothpaste, feminine hygiene, incontinence pads, shampoo, soap, combs
- ▼ MEDICAL: vitamins, first aid kits, antiseptic wipes, emergency blankets, fire blankets, thermometers, cotton balls, bandages, nappies, wheelchairs, crutches
- ▼ PET: food / general supplies
- ▼ INFANT/CHILD: nappies, milk powder, wet wipes, baby food
- ▼ CLOTHING: winter coats, shoes, boots, new underwear
- ▼ OTHER: water filters, camp beds, tents etc.



# BAGS OF LOVE

Ukraine Relief are running a permanent scheme called Bags of Love. This is similar to the 'shoe box' appeal, but even easier! All you have to do is follow three simple steps:



## Step 1

Request a bag and label from Sam Dunlop /SNUG. You can have as many bags as you/your friends can realistically fill.

## Step 2

Fill each bag with gifts/items suitable for a chosen gender/age and then complete the label to identify this - e.g. girl/boy, aged 5-8, adult female/male/unisex etc.



## Step 3

Contact Sam Dunlop/SNUG to return the filled and labelled bag(s) which will then be taken to Ukraine Relief for urgent distribution in Ukraine.

Bag filling ideas: new or very good condition items such as cuddly toys, dolls, small games, sweets (no chocolate, as it melts), biscuits, books, colouring books, pencils, pens, toiletries, soaps etc. Please avoid fragile/glass items and battery/electrical items.

If you are unable to fill a bag, then you can donate funds and Sam Dunlop/SNUG will buy items and fill bags on your behalf.

### FOR MORE INFORMATION:

Contact Sam Dunlop 07720 305613, 01329 833268, [samandmattdunlop@btinternet.com](mailto:samandmattdunlop@btinternet.com)

# In your garden ... Getting Ahead



We are just about to embark on my favourite season in gardening.

The feel of the garden has shifted from that of frantically trying to pull up weeds, dead heading and mowing on a weekly basis to something far calmer and more calculated. It is no time to be resting on your laurels as there is much to be done in the garden. Interestingly, the turn of phrase, 'resting on your laurels' comes from the ancient Greek and Roman societies where high-achieving people were awarded crowns made of laurel leaves to mark their accomplishments.

This season separates a good garden from a great garden next year. People appreciate a beautiful building but I'm yet to hear a comment about how 'immaculately flat' or 'well poured' a foundation is but it is fundamental in holding the whole building up. That is what autumn is to your garden – the foundation. It's a mixture of tidying up the previous seasons growth and preparing for the next year.

## Cutting back - Looking back

Most of us aim to have successional planting so as one plant starts to lose its shine another takes its place. For the next plant to have its stage the previous one needs to be cut back to allow space. herbaceous perennials like delphiniums, lupins, peonies and phlox would fall under this category. If tall and messy they can have the dead flower stems removed although If you have the space and inclination to leave a few perennials in place for the wildlife I'm sure they would appreciate it.

Now is also the time to be cutting back your soft and bush fruit. Thin out blackcurrants, gooseberries, and redcurrants by pruning out the fruited stems with an aim to create a good airflow through the plant.

Your Mediterranean shrubs like rosemary and lavender benefit from a cutback this time of year but leave tender French lavender until spring.

## The preparation begins!

You are in the midst of tidying, sorting, and repairing but there is also preparation to do for next year. Taking cuttings as you trim back some of your favourite shrubs like Abelia, Deutzia and Ribes can seem very daunting, but it couldn't be easier. Visit [rhs.org.uk](http://rhs.org.uk) and search hardwood cuttings for a comprehensive step-by-step guide of how to do this.

In autumn the soil is moist and warm – perfect for establishing plants before winter sets in. If you are buying in person it is perfectly acceptable to gently lift the plant from its pot to see the roots – this overall is what you are really paying for. You are looking to see evidence of roots reaching to every part of the pot but not so much that all you see is root.

The main tip I can give is to do these things little and often. A bad spell of weather can really put you behind but clearing leaves off the lawn, cutting back the occasional shrub and taking the odd cutting will put you in good stead.

The Tudor Gardener



## Autumn Plant sale

### Where:

Droxford Village Hall  
Droxford High St.  
SO32 3PA

### When:

Saturday October  
5th  
10.00 - approx. 11.30

### Products:

Plants  
Vegetables  
Fruit  
Home bakes





**This year's Royal British Legion Service of Remembrance will be held on Sunday 10<sup>th</sup> November 2024 at St Peter's Church, Soberton commencing at 1050. The service will be followed by wreath laying at the Soberton war memorial at Webb's Green and the memorial lychgate at Newtown at approx 1230 and 1250 respectively.**

**The national two minutes silence will be observed at 1100 on both Sunday 10<sup>th</sup> and on Armistice Day on Monday 11<sup>th</sup> November.**

We have recently commemorated the 80<sup>th</sup> anniversary of Operation OVERLORD (colloquially known as D-Day). Allied forces sustained 10,000 casualties on D-Day itself (6<sup>th</sup> June 1944), of which 2,700 were British and 946 Canadian. Casualties throughout the Normandy campaign (6<sup>th</sup> June - 21<sup>st</sup> August 1944) reached 209,000 of which 37,000 were killed. In all, the two world wars of the 20<sup>th</sup> Century accounted for the loss of nearly 1½ million British and Commonwealth soldiers, sailors and airmen. Since 1945, 7,190 British Servicemen and women have been killed in the service of this country across the globe, including Palestine, Korea, Malaya, Borneo, Suez, Cyprus, South Atlantic and the Falkland Islands, The Balkans, Iraq, Afghanistan and Northern Ireland. Ongoing operations in Ukraine and the Middle East are a reminder that war, and its cruel consequences, are a constant threat to peace and freedom.

Detractors (and there are a few) invariably claim Remembrance ceremonies glorify war. Really? Try telling that to the mothers, fathers, wives, husbands, sons and daughters of those who lost their lives. I wonder how John and Mary Twynam of Soberton House, who lost four sons and a son-in-law during the Great War, would have responded to such a claim? There are those who support wearing a white poppy (for peace) as opposed to the red poppy but this misses the point. The red poppy was chosen as it grew in abundance in the devastated wasteland of Great War battlefields. It therefore helps remember not only those who died but also reminds us of the horrors of war and the personal sacrifice made, raising badly needed funds to keep remembrance alive and support our Servicemen and women, veterans and their dependants. In addition to remembering those who died, the RBL supports the many more who sustained life changing physical and mental injuries that may need a lifetime of care. During the recent campaign in Afghanistan, 457 Service personnel were killed and some 2,200 injured of which 616 were classified as serious or very serious. The RBL has no view on wearing white poppies, either on their own or alongside red ones. Both advocate peace but only the red poppy raises funds to support the injured or bereaved. Wear your poppy with pride.



*The RBL Droxford & District Branch is always looking for new members, both Service and civilian, to help keep remembrance alive and support our Servicemen and women, veterans and their families. For more information or to join us, please contact the Secretary – Cdr Rob Scott RN at [robmunroscott@aol.com](mailto:robmunroscott@aol.com) or 01489 877800. [www.soberton.org/rblweb](http://www.soberton.org/rblweb).*

## **Children's Week 2024 – obstacle course at Meonwood**



## **Local History - Mrs Hants ..... in Soberton**

No, this article is not about a Beauty Contest for mature Hampshire women taking place in Soberton. In fact, Mrs. Hants is not a woman but the secret location for a Roman Catholic Refuge in Soberton sometimes referred to as "Kirby's". However, it may be that before a permanent centre was found at Southend in Soberton there had been other places in the neighbourhood where temporary "Mrs. Hants" had been located. Important Catholic families such as the Goldsmiths and the Brunings at Hambledon might have provided accommodation until it became too risky; the Henslowes at Boarhunt were known to have sheltered a priest. According to tradition Mr Ludlow of Cams Hall aided many priests who sailed up Fareham Creek and in 1583 he was imprisoned at Winchester for "harbouring massing priests"

Women seemed to stay with the old faith longer than men and perhaps these three Soberton women were excommunicated for six months in a visitation by the archdeaconry in 1607-8 Margaret Hooker, later to be buried at Soberton, Margaret Hore and Ann Rowland.

The Compton Census of 1676 records there were ten papists in Soberton parish. Ninety years later the number had risen to "about 39" and a "chapel belonging to the Roman Catholics is mentioned". Miss Jane Cotton was said to be the original donor and Lord Arundell of Wardour acted as trustee and maybe provided the premises. Both of well-known catholic families.

It was not just a refuge for priests there was chapel attached to the farmhouse serving a wide community. It is recorded that when Bishop Challoner visited Southend on July 2<sup>nd</sup> 1741 there was a congregation "numbering one hundred, of whom he confirmed forty. One wonders how far some of the congregation had travelled.

The Soberton burial register provides the names of some of the catholic families buried there including familiar names of Reeks (1678, 1680 and 1740) Glasspole (1746), Knight (1787), and Molden (1739). Francis Short, a Roman Catholic Priest, was buried in 1755. It has been mentioned that there are mounds, suspected of being burial mounds behind Southend farmhouse.

We do know that in latter years the Fathers at Southend played a part in village affairs. One even took the Soberton parish Officers to court for neglect of a poor family, without success,

It has been stated that for a hundred years the only place where mass could be heard in this corner of Hampshire was at Southend until in 1873 a Catholic Mission set up in Fareham with a military chaplain mainly for the Hill Forts.

A descendent of the Reeks family, a member of the Local history Society, supplied information about a move from the Fareham-Soberton area to a hamlet called Old Hall Green in Hertfordshire. Some of the Soberton community moved there, possibly because a school for Catholic boys was built nearby

We are fairly certain that the chapel was used as a school for Newtown children when the old schoolhouse was pulled down to build Holy Trinity Church and until the new school was built in 1851. After that it was used to house agricultural equipment before it too was demolished.

## **Need Transport to Medical Appointments?**



SOBERTON AND NEWTOWN  
**Good Neighbours Group**

**Call Kate Harvey on: 07843 496 852**

**Kate Chesters on: 07710 716 664**

**[www.soberton.org](http://www.soberton.org)**

## The Meon Valley Parishes

# Finding a new way of working

**When Andy Davis became Priest in charge of Meon Valley Parishes in February, he effectively took on eight parishes. Here he explains the diocese's vision for this new amalgamation.**

In order to understand the challenges that we face to sustain and grow the life of our church communities, and to understand the pattern of ministry that is now being explored in the Meon Valley Parishes (including why the wider church will only fund one full-time priest, whereas in 2015 there were five in our area), we need to acknowledge the current state of the Church of England – as explained in the “Post Script” at the end of this piece.

But...with God, all things are possible! Times of challenge should be times of greater blessing because they make us turn to God afresh, in prayer, service, love and humility – seeking the grace of Christ, in and through the sustaining love of our heavenly Father, in the power of the Holy Spirit. As many poorer Christians across the world show us, there is joy and renewal to be found in the face of adversity.

### A new vision for three benefices

Previously the parishes have been collated into three benefices:

- ♣Swanmore,
- ♣Droxford, Corhampton with Meonstoke and Exton (the “Meon Bridge” or “Bridge” benefice), and
- ♣Hambledon, Soberton and Newtown

(the latter two having been linked together for many years).

Each of the three benefices used to have priests operating in a “solo” role. The new vision for the Meon Valley provides for a generous measure of ministry resource, based in “self-supporting ministry” (see below) and seeking to encourage:

- ♣collaborative working, especially to avoid ministering in isolation;
- ♣parish distinctiveness– this is very important – honouring identity and the “folk memory” that is part of every parish and church community;
- ♣encouraging the rich vein of talent and dedication found among our congregations.

Bishop Jonathan presented a particular vision of the development of a community of clergy, “Anna Chaplains”/friends (ministering to the elderly), and lay worship leaders – all working together in a co-ordinated way, and responding to the Bishop’s call for parishes to develop their own leaders, rather than rely on the Vicar to do everything.

### First steps

I have been appointed “Interim Priest-in-Charge” of the Meon Valley Parishes (MVP) to explore how best to provide ministry in a changing environment across eight church

buildings. I am delighted to be working with Revd Liz Quinn, who is also licensed to the MVP, but with a particular focus in Hambledon, Soberton and Newtown.

We are so fortunate to have a significant number of local clergy, readers and others who willingly populate our service rotas and provide cover for so many Sunday and weekday services, plus baptisms, weddings, funerals, and other ministries.

It is also wonderful to have licensed lay workers, lay worship leaders, churchwardens, secretaries, administrators, treasurers, vergers, musicians, choir members, sides-people, cleaners, churchyard maintenance, group leaders, caterers, social event organisers and helpers, flower arrangers...an endless list. Many others in our village communities offer a huge range of skills to the church, with enthusiasm, dedication and goodwill. (Over the years I have been privileged to work with many members of the community of different faiths or none.)

The overall aim is for all these skills to be used more widely, sharing experience and good practice in a variety of ways: faith development, worship, safeguarding, buildings, administration, etc.

### Communities and buildings

Fundamental to the flourishing of our churches are:

- ♣an active and vibrant relationship with the local and wider community and



St Peter's, Soberton.



St Peter & St Paul, Hambledon.



St Andrew's, Meonstoke.

❖ensuring our church buildings are used as much as possible, are lively community hubs, and places of holiness, depth and mystery.

We are putting in a bid to the national church to provide significant funding for five years (including paid posts) for administrative and IT support, plus support for work with children, young people and families. These funds are part of the Strategic Mission and Ministry Investment (SMMI) initiative to create sustainable projects that will have an impact in the long term.

### All sorts of clergy

It is worth noting that, increasingly, many clergy receive a more specific training, such as in youth work, family work, and community work. Some are called to be “Pioneer Ministers”. Pioneers are people “called by God, who are the first to see and creatively respond to the Holy Spirit’s initiatives with those outside the church; gathering others around them as they seek to establish new contextual Christian community”.

It might be that we can benefit from “specialist” ministry appointments, as well as appointing those who minister in the general style of a “parish minister”. These days, the majority of the clergy in the Church of England are part-time, and fall into three main categories (listed below). An increasing trend is therefore to appoint just one full-time stipendiary priest to oversee such a variety of ministry:

❖**Self-supporting ministers:** SSMs are ordained, licensed clergy. Clergy

are given a licence by a bishop, which gives them authority to minister in a particular context for an unlimited period (under “Common Tenure”) or for a particular period of time (perhaps 3 or 5 years). SSMs offer their ministry on an unpaid basis, and they make a vital and important contribution to parish ministry. In England around 30% of licensed clergy are SSMs.

❖**Retired clergy:** Retired clergy are given “Permission to Officiate” (PTO) rather than a licence. To have a PTO essentially means that you are ministering with the support of both the Diocesan Bishop, and the clergy responsible for the parish(es) where you serve. Retired clergy offer a very significant resource for our parishes, through their willingness to take services and offer pastoral care. About one-third of serving clergy are retired.

❖**House for duty:** House for duty clergy are SSMs who, in exchange for being given a vicarage or another clergy house to live in (and usually working expenses), offer ministry – typically covering Sunday services and perhaps two to three days a week (or more if they wish). This role is suited to clergy who have a partner with a paid job, who themselves have a part-time secular job, who have taken early retirement from another job, or who are easing into retirement from a stipendiary (paid) clergy post. It also appeals, because a “house-for-duty” priest can concentrate on worship, visiting and community work, but doesn’t

have to be concerned with overseeing the more legal/formal duties of a parish priest (e.g churchyard regulations, managing PCCs, overseeing safeguarding, etc). These responsibilities are covered by the stipendiary (paid) clergy. A house for duty priest gives parishes the benefit of a resident priest, albeit part-time, who lives and serves in a particular place and gets to know the people there.

A start date for any newly-appointed minister is difficult to predict because each appointment will be dependent on a number of factors, including:

- ❖diocesan timescales;
- ❖preparing the house if they are going to occupy one of the vicarages (e.g tenants vacating, repairs and improvements being made to the house and garden – usually the responsibility of the diocese);
- ❖whether the appointment is to be by advertisement or nomination – that is, approved and recommended by the bishop;
- ❖the date when the appointed person is available to begin.

A person appointed to the benefice would have a particular location and/or focus for their ministry, but would also offer their gifts and talents across the Meon Valley Parishes as a whole.

### Post Script

As mentioned above, in order to understand the huge challenges that we face to sustain and grow the life of our church communities, and to understand the pattern of ministry ►



*Holy Trinity, Newtown.*



*St Peter & St Paul, Exton.*



*Corhampton Church.*

that is now being explored in the Meon Valley Parishes (including why the wider church will only fund one full-time priest, whereas in 2015 there were five), we need to acknowledge the current state of the Church of England. All the following statistics are taken from Census data and the British government's "Social Attitudes Survey".

1. The number of people who identify as "Christian" in the UK has nearly halved in just 25 years.
2. The biggest decline among all Christian denominations is for those who identify as "Church of England": from 66% of the population to just 12%.
3. In 2019, for the first time in history, a majority of the UK population identified as "non-religious" (52%) - an increase of 70% since 1979.
4. Although 12% identify as Anglican, only 800,000 actually attend a Church of England church "frequently" (which doesn't mean weekly, but once a month or more frequently).
5. Anglicans (800,000) are outnumbered by Muslims (over twice as many attend worship - 1.9 million) and Roman Catholics (1.2 million).
6. The average age of Anglicans in the UK is 65. This of course means that a significant number are a good deal older.
7. Less than 1% of 18 to 24 year-olds identify as Anglican. 88% of that age group say that they do not even believe in God.



St Mary & All Saints, Droxford.

8. 91% of the UK population say that the Church of England has either "very little relevance" or "no relevance" in their day-to-day lives.
9. More than 400 Anglican churches have closed in the last ten years. This was an eight-fold increase from the 50 that closed in the previous ten years. The trend suggests a rapid acceleration, with another 400 churches closing in the next five years.
10. If current decline continues, there will be no Anglicans worshipping in the UK in 20 years time.

### **Changes in church "culture"**

1. The Christian faith is rooted in history - and is centred on certain people and certain events. Fewer people know that story anymore. For example, many children know nothing of Jesus, or the main events in the Bible, and even less about the life of the Anglican Church.
2. Sundays have changed beyond recognition: 50 years ago, going to church was one of a small number of options. These days, many more things are possible on a Sunday morning (shopping, sport, car boot sales; or simply a time to rest and be with loved ones).
3. Many more people are against "established" religion (including any form of organised worship). In part, this is due to a rejection of "authority", which is seen in many other walks of life - notably in the decline of trust in civic and political institutions.



St Barnabas, Swanmore.

4. Although the increased interest in "spirituality" may sound positive for Christianity, it is often self-centred, rather than God-centred: what "works for me", rather than what might be rooted in universal truth.
5. Holding a "belief" or having "a faith" are not things that command respect. In fact, they are often ridiculed. In large part this is because there is a significant minority of people that believe in conspiracy theories and falsehoods that are propagated online.
6. There has been an increase in powerful and thoughtful attacks on religious belief. The most famous might be *The God Delusion* by Richard Dawkins but more challenging to Christian faith (in my opinion) is *God is not Great* by Christopher Hitchens - and even more challenging still (because of its use of psychology and neuroscience), *The End of Faith* by Sam Harris.
7. There is intense debate within the church about whether to cling to traditional beliefs and practices or whether to embrace a more contemporary approach (for example, the intense debates about sexuality and marriage). In the 1990s, churches in Portsmouth tracked down 600 people who had stopped going to church. Of these 42% said that they had left because the church had modernised too much. The exact same percentage said they had left because the church was unwilling to modernise.
8. It was accepted for hundreds of years that religious faith improved behaviour. Today we are far more aware that:

- ♣ goodness and moral courage are found in people of all faiths and none, and
- ♣ religious beliefs can make some people even more cruel and intolerant (this is set out powerfully in Hitchens' book, mentioned above).

Revd Andy Davis  
 revd.andydavis@gmail.com  
 07709 919602

# SOBERTON PARISH COUNCIL - *Chairman's notes*

*inc Newtown, Hundred Acres, Hoegate, Soberton Heath, Kingsmead, Brockbridge and Soberton*

## **Soberton Parish Council: Appointment of Parish Clerk**

The Parish Council has appointed Cheryl Gosling at the Clerk and Responsible Financial Officer (RFO). Cheryl started on 18 September having been approved by the full council meeting of 17<sup>th</sup> September. Cheryl is a highly qualified and experienced clerk and will be working for SPC for 10 hours per week. Our recently retired clerk Brendan Gibbs will be handing over the council's data together with contacts, bank details etc. Cheryl's first meeting is scheduled to be 22<sup>nd</sup> October. Among Cheryl's first tasks is completing the audit submission to the government appointed external auditors, Brendan has largely completed this exercise except for the submission itself.

The Clerk/RFO to the Council is the Proper Officer of the Council as required by the Local Government Act 1972, and is required to carry out the statutory duties of a Proper Officer, guiding and assisting the Council in the fulfilment of its legal and financial obligations and undertaking the specific responsibilities contained in the Council's Financial Regulations.

Cheryl Gosling's contact email [clerk@soberton.org](mailto:clerk@soberton.org)

## **Retirement of Parish Clerk**

As noted in last month's parish magazine Mr Brendan Gibb retired in August. Brendan has been clerk to the PC for three years and in that time has worked tirelessly through challenging times to bring the council up to date with new and changing legislation. On behalf of my fellow council members, I thank Brendan for his hard work and diligence to the tasks required during his tenure. We all wish him the brightest of retirement and hope that easing back on his commitments allows him much needed leisure time.

## **Soberton Recreation Ground** (Heath Road, Soberton)

The PC is pleased to report that a specialist contractor has been appointed to carry out works to the field of play at the Recreation ground. The work has now commenced and we hope will be completed by November. The work includes drainage, levelling and seeding. The children's play area (CPA) also requires considerable investment. The PC are exploring a series of options and the availability of grants to assist with the costs. The CPA requires constant attention and is inspected regularly by third party inspectors and work will be carried out to ensure the equipment remains safe for users. This winter some of the trees around

the Recreation Ground will be pruned and the ditches cleared.

## **Annual Maintenance Footpaths and Bridleways**

As previously noted, there are many miles of footpaths and bridleways which cross the Parish, these should all be maintained by landowners including gates, stiles etc. Many of these routes are becoming overgrown and we again urge landowners to clear paths to ease access for walkers and cyclists. Please report overgrown paths to the Parish Clerk who will direct any comments to the appropriate agency or landowner.

## **Roads and Lanes a Road Safety concern**

Hedgerows adjacent roads and lanes across the parish are impeding visibility, it is the landowner's responsibility to prune/cut back this year's growth. This has become an urgent task in some areas and we urge everyone who is responsible for hedges adjacent to lanes to carry out maintenance now making our parish a safer place to walk, cycle, ride and drive.

## **Pot Holes on Roads and Lanes**

The Highway Authority is Hampshire County Council (HCC) and they have a dedicated webpage to report problems such as potholes and, crumbling edges. [Report a problem | Hampshire County Council \(hants.gov.uk\)](https://www.hants.gov.uk) please report directly to HCC.

## **Traffic Safety**

The PC owns a speed indicator sign (SID) which has been deployed across the Parish with reasonable success in encouraging traffic to respect speed limits. The PC has appointed a new contractor to manage the unit and move it from time to time to agreed locations across the parish.

In addition, upon our request, HCC will be carrying out their own traffic surveys on roads of particular concern, namely Church Road, Liberty Road and Heath Road.

## **Councillor David Salmon retires**

Councillor David Salmon has retired as a Soberton Parish Councillor.

David has given more than twenty years of his time to the PC, his regular attendance at monthly meetings will be missed, he took responsibility for the lengthsman (funded by HCC) who are general contractors who visit the parish every six weeks to carry out small but important tasks around the parish. In the early days of the scheme David would buy the workers fish and chips for lunch, his view was

that this treat ensured all of the tasks he set for the day were completed.

**John Hyland**  
**Chairman**  
*chair@soberton.org*

David, on behalf of the PC and the residents of the parish, we thank you for your time and wisdom.

[www.soberton.org](http://www.soberton.org)

## Mad dogs and Children's Week go out in the midday sun!

You will hear many complaints about the summer of 2024, e.g. 'what summer'?! Children's Week 2024 had no such complaints! The week starting 29<sup>th</sup> July was scorching, and hydration and suntan lotion were the order of the day, waterproofs not needed!

Circa 65 children and 18 teens (and lots of adult helpers!) spent the week having fun and doing what summers holidays are all about, enjoying the great outdoors, no mobile phones and box sets in sight!

The topic this year was 'Read All About It' with each group named after a book or series of books. You may have seen the wonderful book models around the village over the summer – this was the main craft activity of each group. So what did we do all week, other than making book covers?

- Monday saw lots of 'good old fashioned' games and races and duck decorating (and the book covers!). A day to get to know each other.
- Tuesday was a 'special fun day' with bouncy bungee and bouncy obstacle courses, dancing mats, HWT nature trail, bounce boots and a story teller – the groups taking it in turns on each activity.
- Wednesday was duck racing and picnic by the Meon river ... a big thanks to Douglas and Imogen Lyndon Skeggs for sharing the river with us! Afternoon, back at the Rec, we made Bookzonie pizzas and mixed, and some were 'privileged' to taste(!), George's magic medicines.
- Thursday – the traditional day at Meonwood. Obstacle course, book themed games / trail, cooking sausages on the campfire and cake decorating. Well, cake annihilation to be honest, but one of the highlights of Children's Week each year – you need to see it to believe it! A big thanks to Sue and Fra Wells for sharing their garden (and cakes!) with us.
- Friday always ends in an evening get together at one of the Parish churches with Parents and friends (St Peter's this year), so the morning was spent learning our lines for the evening and then we finished our model books. The afternoon ... well, how can we explain it! You need to see these games to believe them! Suffice to say, much ice-cream was consumed and much chocolate eaten (with a knife and fork in fancy dress, of course!).

Throughout there was much singing, dancing, laughter, playing and making new friends - a perfect week, now in its 51<sup>st</sup> year! A big thank you to the adults and teens who work so hard to make it such a success! To the NQTs ... your turn as teens next year. And to the all the children – thank you, you were amazing!

So, if you read this and think, what is this 'cake thing' or if anything else resonates with you, please contact us and see how you can join the team of helpers. You will be very welcome and have a most rewarding week!

See you next year! (*More pics on pages 34 and 39*) email [sncweek@gmail.com](mailto:sncweek@gmail.com)

*The Parish Magazine Committee was delighted to sponsor Children's Week (Wednesday)! (£200)*





**Droxford Village Hall,  
St. Marys and All Saints Church  
& Wilfrid's Café**



**DROXFORD  
CHRISTMAS  
MARKET**

**Saturday 16<sup>th</sup> November 2024**  
**10.00am – 3.00pm**  
**Free Parking & Admission**

- Food & Drink ● Local Produce ●
- Festive Crafts & Gifts



**BOTLEY CHORAL  
SOCIETY**

**Brahms REQUIEM  
Karl Jenkins TE DEUM**

Conductor David Burgess  
Organ Mark Dancer

**7.30pm Saturday 23rd November**  
**St John's Church Locks Heath SO31 6LW**

**7.30pm Sunday 24th November**  
**All Saints' Church Botley SO30 2EA**

**TICKETS £15**

**WWW.BOTLEYCHORAL.CO.UK**  
**BOTLEYCHORALSOCIETY@GMAIL.COM**



**Locks  
Heath  
Tickets**



**Botley  
Tickets**

**Meon Valley Carers Group**

For carers of someone with Dementia  
 Receive support, information and signposting  
 Meet and talk to others carers in similar situations

4th Tuesday of each month 2pm - 4pm  
 at The Paterson Centre, Church Road, Swanmore, SO32 2PA

The programme for these meetings is varied with speakers ranging from necessary, interesting, factual information to more lighthearted subjects.

Built into the group meetings are arts and crafts, musical afternoons and games suitable for those living with Dementia.



You will be given a warm welcome!



Tea coffee and biscuits provided

**Free parking in the car park opposite the Paterson Centre**

If you are not already registered with us, please contact our Referrals and Enquiries Team  
 Telephone: 01264 332297 (select option 3)  
 or email [enquiries@andovermind.org.uk](mailto:enquiries@andovermind.org.uk)



**Wickham Society Autumn Programme 2024**

Meetings are held at the Wickham Community Centre starting at 7.30 pm. Membership is £6 per annum or £2 for an occasional visitor. New members and visitors are always welcome.



**8 October 2024**  
**National Garden Scheme**  
 gives unique access to over 3,500 gardens, raising vital funds for nursing charities – a talk by Martin Porter, County Organiser



**12 November 2024**  
**Hampshire & Isle of Wight Air Ambulance** – find out about the work and role this life saving charity carries out every day



**10 December 2024**  
**Ministering Angel**  
 Meet Nursing Superintendent Shaw, a good friend and colleague of Florence Nightingale who worked at Netley Hospital



A joint meeting with Wickham History Society

For more information see our website or contact Wendy Greenish at [wendy.greenish@gmail.com](mailto:wendy.greenish@gmail.com) or 01329 833583  
[www.wickhamsociety.org.uk](http://www.wickhamsociety.org.uk)

# WINCHESTER CITY COUNCIL – District Councillors

As the summer season transitions into the vibrant autumn months, we are excited to share some important updates and opportunities for the Meon Valley community.

## Community Engagement: Your Voice Matters!

We believe that every resident's voice is essential in shaping our community. Join us for our upcoming Councillor Surgery, which will take place on **Monday 21<sup>st</sup> October at The White Lion, Soberton (in the bar) from 11 a.m.- 12.30 p.m.**, an opportunity to share your thoughts on any local issues, inc. housing, transport, and environmental initiatives.

## Local Environmental Initiatives: A Greener Future

We are delighted to see local groups like Hambledon Greening, Sustainable Droxford, Sustainable Waltham Chase and Swanmore (SWaCS) and Climate Action for Newtown and Soberton (CANS) thriving and pushing for a greener future. See the C.A.N.S. article to find out what they have been up to in your local area.

## Changes to Waste and Recycling Services

Winchester City Council (WCC) is changing the waste and recycling collections from Autumn 2024 to enhance service efficiency and prepare for future waste management regulations in 2026. New collection routes will be launched on 7th October. Updated bin collection information letters will have been distributed to affected residents from 9th September.

A new electric waste collection vehicle will also be trialled on various routes across the district, and residents will be informed when it will be operating in their area.

## Playing Pitch Strategy and Sports Facilities Needs Assessment

WCC is updating its Playing Pitch Strategy and Sports Facilities Needs Assessment to guide priorities until 2040. The first phase of consultation with local sports groups and site inspections concludes in December 2024. For more information, contact Laura Jones at [ljones@winchester.gov.uk](mailto:ljones@winchester.gov.uk)

## 'Spaces of Sanctuary' Training

WCC offers Equality, Diversity, and Inclusion (EDI) training as part of the 'Spaces of Sanctuary' initiative, encouraging businesses and organisations to provide

inclusive, respectful environments. For details, contact: [communities@winchester.gov.uk](mailto:communities@winchester.gov.uk).

## WCC Corporate Peer Challenge

This summer, your Councillors took part in a Corporate Peer Challenge with Local Government Association peer reviewers. We were able to emphasise the *need for a better balance between urban and rural priorities*. The feedback report and an action plan is aimed at improving the Council's performance, with a progress review 10 months after publication.

## Water Crisis: Too Much, Too Little, Wrong Place, Too Expensive and Polluted

Cllr Danny is challenging key water authorities on high costs, poor environmental protection, and limited infrastructure to tackle the ongoing water crises. He is also calling for a reappraisal of the Hampshire Water Transfer and Water Recycling 40km pipeline project, citing outdated assumptions and missed opportunities for integrating climate resilience, renewable energy, and improved natural habitats, broadband upgrades, cycling and walking. For more information, visit [tinyurl.com/bdcsuzn8](https://tinyurl.com/bdcsuzn8) and [tinyurl.com/mvyvh325](https://tinyurl.com/mvyvh325).

## Support and Funding Opportunities from HCC and WCC

### District Small Grant Scheme

Funding is available for projects aimed at community engagement or new initiatives. The scheme closes on 28th February 2025, or earlier if fully allocated. Find out more: [www.winchester.gov.uk/grants-for-not-for-profit-organisations](http://www.winchester.gov.uk/grants-for-not-for-profit-organisations)

## Solar Together – Group Buy Scheme for Solar Energy

Hampshire residents can join the scheme to invest in solar panels installed by vetted suppliers. Register by 18th October for a free, no-obligation quote at [www.hants.gov.uk/solartogether](http://www.hants.gov.uk/solartogether)

## Stay Informed

To ensure you are informed with the latest news, initiatives, and community resources, keep an eye on the WCC website and our Facebook page - [www.facebook.com/meonvalleycouncillors/](https://www.facebook.com/meonvalleycouncillors/). Your engagement helps us to serve you better!

Together, we can continue to make the Meon Valley an exceptional place to live, work, and play.

Enjoy the Autumn magic.

Cllr Malcolm Wallace ([mwallace@winchester.gov.uk](mailto:mwallace@winchester.gov.uk))

Cllr Danny Lee ([dlee@winchester.gov.uk](mailto:dlee@winchester.gov.uk))

Cllr Suzanne White ([swhite3@winchester.gov.uk](mailto:swhite3@winchester.gov.uk))



## Outstanding

Children in Hampshire continue to benefit from strong and effective services that make a positive difference to their lives.



This is one of the key headline findings from Hampshire County Council's latest full Ofsted inspection, which has again rated its Children's Services outstanding.

## Schools being Consulted

Hampshire County Council is proposing to close its Education Catering service by 31st March 2026 and is consulting with schools and nurseries which use the service on two potential options to meet their catering needs in future.

These are:

- For schools and nurseries to arrange their own catering provision. (There is an active, well-established private sector market of school food providers operating successfully in Hampshire, from which schools can select).
- To provide a managed outsource of the service which schools and nurseries could buy into. This option would see the County Council procure and manage the supply of meals from alternative providers, on behalf of schools and nurseries.

Education Catering, formerly known as HC3S, has experienced significant financial pressure in recent years due to the combined impacts of rising food and staff costs. To cover its costs, the Local Authority has needed to increase the price of its school meals above the funding rate provided by Government to schools.

This has resulted in a loss of business and as such, the County Council can no longer continue providing a non-statutory in-house service in the long term without making a loss.

The current consultation runs for a period of five weeks until Friday 11th October.

## Secondary School Places for September 2025

Applications opened on 9<sup>th</sup> September until 11:59 pm on 31st October for pupils who are currently starting Year 6 [see online



<https://educationonlineportal.hants.gov.uk/EducationOnlinePortal/en>].

To improve your chances of getting into a preferred school, remember to name three schools on your application.

## Smokefree Hampshire

With ambitious plans to significantly increase the number of Hampshire smokers quitting each year by 2030 from the current 3,500, Hampshire County Council has signed a new pledge to take even more action to reduce the harm caused by smoking across Hampshire communities.

Smoking is the single biggest preventable cause of ill health and premature death in England, costing the taxpayer millions and placing a huge burden on the NHS and social care. Therefore, helping people to quit smoking is vital and is one of HCC's key legal responsibilities.

In 2022, it was estimated that 10.5% of adults living in Hampshire smoked. Around 4,500 Hampshire residents die because of smoking each year, with a further 8,600 admitted to hospital.

The County Council's action plan includes working with local GPs, hospitals, social housing and adult social care providers, as well as the local voluntary and community sector to boost referrals into the county's free quit smoking service - Smokefree Hampshire, plus more outreach work to engage with those who traditionally do not seek help from formal quit-with-support services. Going forward, there will also be greater support for pregnant mums, as well as help for children and young people to quit electronic cigarettes (vapes) via a dedicated, free service working through local schools and colleges. This builds on current work to create smokefree sites and provide resources for teachers, parents, and carers around smoking and vaping.

## Finding more Foster Carers

Hampshire County Council has joined 19 other councils in the South East to form the country's largest local authority fostering partnership, in a bid to increase the number of foster carers across the region

With over 11,000 children in care across the South East, and fewer than 3,000 local authority approved foster carers, there is an urgent need to find more people to provide safe, loving, and local homes for vulnerable children.



If you care about making a difference in your local community and have a room to spare, please consider fostering and get in touch with the Hub's friendly recruitment team on 0300 131 2797 to find out more. More information on becoming a foster carer can be found on Local Authority Fostering South East new website - <https://www.lafosteringse.org.uk/>

Prospective carers can also contact the regional hub directly to speak to a member of the recruitment team by calling 0300 131 2797. To contact Hampshire County Council's fostering service directly, call 01489 587052 or email [fostering@hants.gov.uk](mailto:fostering@hants.gov.uk).

## Prestigious Green Flag Awards

Visitors to Hampshire County Council's five country parks are guaranteed a top-quality day out thanks to the parks being once again awarded Green Flag awards for 2024. Lepe, River Hamble, Royal Victoria, Queen Elizabeth, and Staunton Country Parks have all once again regained Green Flag status for their excellent facilities and amazing outdoor spaces. Staunton Country Park and Royal Victoria Country Park have also once again won Green Heritage Accreditation for the management of the sites' unique historic features - Lepe Country Park has also secured the heritage accolade this year for the first time.

## Increase in Annual Road Repairs

An unprecedented number of potholes and road defects have been fixed across a 12-month period, according to the latest figures from Hampshire County Council From April 2023 to April 2024, 180,909 repairs were delivered, marking a 37 per cent increase. One year ago, HCC allocated an additional £22.5 million to tackle this issue and make our roads stronger.

With unprecedented volumes of potholes being reported to us, Hampshire is not alone in facing the challenge of keeping local roads in a good condition. The impact of colder, wetter winters takes a heavy toll on the roads, and higher costs due to inflation means that every year we must make our budget stretch further – for example, it now costs the taxpayer around 44% more to repair a pothole.

## Community Grants

Don't forget that grant applications for a Councillor grant are now open. These grants are intended to help small, local, community groups eg lunch clubs, scouts, community centres, village associations, school PTAs, local Church, etc. Grants allocated are fairly small and MUST meet the published criteria. See - <https://www.hants.gov.uk/community/grants/grant-s-list/county-councillor>.

Also, you must discuss with your County Councillor BEFORE application is made. All applications must be made online. *I look forward to hearing from you!*



Patricia Stallard  
Hampshire County Councillor  
Winchester Southern Parishes  
[Newlands, Denmead, Southwick, Boarhunt, Wickham, Knowle, Soberton, Newtown]

[patricia.stallard@hants.gov.uk](mailto:patricia.stallard@hants.gov.uk)

## POP IN FOR COFFEE AND CAKE

at ST PETER'S CHURCH ROOM, SOBERTON

POP IN FOR COFFEE & CAKE ON THE 2<sup>nd</sup> AND 4<sup>th</sup> WEDNESDAY IN THE MONTH  
10AM – NOON

MEET FRIENDS, MAKE NEW FRIENDS AND HAVE A CHAT



# Meon Valley Community Bus Association Timetable



Mondays, 2 <sup>nd</sup> and 5 <sup>th</sup> Friday to FAREHAM	
0900	West Meon Thomas Lord PH
0903	Warnford Village Hall
0908	Exton The Shoe PH
0910	Meonstoke PO & Stores
0914	Meonstoke Pound Cottages
0921	Droxford Square (PARK & RIDE)
0925	Brockbridge The Hurdles
0930	Soberton Village Hall (PARK & RIDE)
0933	Webbs Green War Memorial
0936	Soberton Heath Chapel Road pond
0938	Soberton Heath Bold Forester PH
0940	Newtown Rookesbury Hall (PARK & RIDE)
0945	Hundred Acres
0957	Fareham Library
1002	Fareham Sainsbury's
<b>Return:</b>	
1200	Fareham Sainsbury's
1205	Fareham Library

3rd Friday Each Month to HEDGE END	
0900	West Meon Thomas Lord PH
0903	Warnford Village Hall
0908	Exton The Shoe PH
0910	Meonstoke PO & Stores
0914	Meonstoke Pound Cottages
0921	Droxford Square (PARK & RIDE)
0925	Brockbridge The Hurdles
0929	Soberton Village Hall (PARK & RIDE)
0933	Webbs Green War Memorial
0935	Soberton Heath Chapel Road pond
0938	Soberton Heath Bold Forester PH
0940	Newtown Rookesbury Hall (PARK & RIDE)
0945	Hundred Acres
1007	Hedge End Marks & Spencer
<b>Return:</b>	
1200	Hedge End Marks & Spencer

4 <sup>th</sup> Friday Each Month to WATERLOOVILLE	
0900	West Meon Thomas Lord PH
0903	Warnford Village Hall
0908	Exton The Shoe PH
0910	Meonstoke PO & Stores
0914	Meonstoke Pound Cottages
0921	Droxford Square (PARK & RIDE)
0925	Brockbridge The Hurdles
0929	Soberton Village Hall (PARK & RIDE)
0933	Webbs Green War Memorial
0936	Soberton Heath Chapel Road pond
0938	Soberton Heath Bold Forester PH
0940	Newtown Rookesbury Hall (PARK & RIDE)
0957	Waterlooville Waitrose
1005	Waterlooville Sainsbury's
<b>Return:</b>	
1200	Waterlooville Sainsbury's
1205	Waterlooville Waitrose

1 <sup>st</sup> Friday Each Month to WINCHESTER	
0900	Soberton Village Hall (PARK and RIDE)
0904	Brockbridge The Hurdles
0909	Droxford Square (PARK and RIDE)
0915	Meonstoke Pound Cottages
0919	Meonstoke PO & Stores
0921	Exton The Shoe PH
0926	Warnford Village Hall
0946	Winchester Broadway
0953	River Park Leisure Centre
<b>Return:</b>	
1155	River Park Leisure Centre
1200	Winchester Broadway

Leave	Wednesdays to PETERSFIELD	Return
0900	Soberton Village Hall (PARK and RIDE)	Petersfield Tesco 1155
0904	Brockbridge (The Hurdles)	Petersfield Sq 1200
0909	Droxford Square (PARK & RIDE)	Warnford George and Falcon 1221*
0916	Meonstoke Pound Cottages	Corhampton 1224*
0921	Corhampton	Pound Cottages 1229*
0924	Warnford George and Falcon	Droxford square 1236*
0945	Petersfield Square	Brockbridge ( The Hurdles) 1301*
0950	Petersfield Tesco	Soberton Village Hall 1305*
<i>Note: Includes all request stops up to and including West lodge (Church lane)</i>		<i>* Drop off only and approx dependent on passenger numbers.</i>

No service on other days or Public holidays. £6 return, £3 single any journey. Bus passes accepted . Under 16 half fare. Under 5 free.  
Dogs allowed subject to driver discretion. Timings are strict, bus will not wait after scheduled time.  
All enquiries to : [mvcb1985@gmail.com](mailto:mvcb1985@gmail.com) ☎07300 425305

A date for your diaries!

**2<sup>nd</sup> October 2024**

**7pm at Droxford Village Hall**

**The Meon Valley Community Bus Association will hold its  
Annual Public Meeting**

This is a great opportunity to learn more about the local community bus.

Meet the Trustees and Drivers.

Explore how you can hire the bus for trips to organised events like open gardens, theatre trips, museums and much more.

Light refreshments will be available after the meeting.





## From the Archives.....

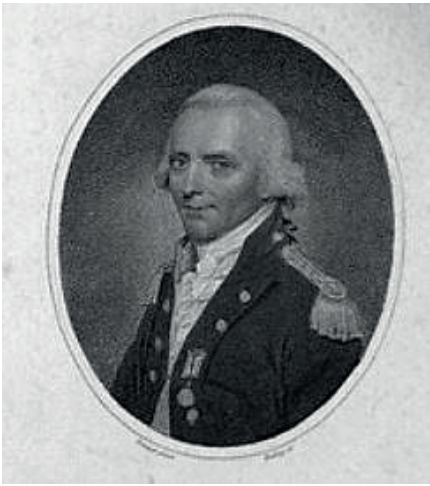

**Above** - L - Admiral Sir John Knight (1747-1831) was a notable resident of Soberton. His naval career started at the age of 11. A major naval figure of his time, at the American War of Independence and at The Battle of Chesapeake against the French in 1781.(top right) He married twice, both times to American ladies. He was unpopular with his men and officers for poor discipline and his habit of taking his wife and children to sea with him! **Below** - In 1788 Knight purchased property in the Forest of Bere at Woodend. This was controversial due to encroachment into Royal lands and fences were put up and taken down again! Undaunted, he built "a handsome house in the Forest", now known as Wood End House & lived there until his death. The house remained in the Knight family until it was sold in 1849 to C Pink, President of the Royal Institute of Chartered Surveyors. (Adapted from a talk by Duncan Colin-Jones and Ann Pendred - with thanks!)



(from the Archives of the Soberton & Newtown Local History Society) any additional information is always welcome.  
Please Contact [duncan.colinjones@btinternet.com](mailto:duncan.colinjones@btinternet.com) or [petewoodacre@gmail.com](mailto:petewoodacre@gmail.com).